

**G  
Z  
V  
V**

# Apartment & Home Communication Products



Door Entry Controllers • Apartment Entry Phones  
Door Entry Phones • Video Entry Phones  
Whole House Paging • Enhanced Weather Protection



Manufactured in the USA / American Technical Support

ENTRY PHONES / DOORBOXES	3-4
VIDEO ENTRY PHONES / PRODUCTS	5
APARTMENT COMMUNICATION	6
ENHANCED WEATHER PROTECTION	7
CONTROLLERS	8-9
ENCLOSURES / MOUNTING / LIGHTING	10
MISCELLANEOUS	11

**How to Contact Us:**

Information: 715.386.8861  
 Online: [www.vikingelectronics.com](http://www.vikingelectronics.com)  
 Email: [info@vikingelectronics.com](mailto:info@vikingelectronics.com)

All Viking products are in-stock nationwide through distributors listed on the back cover.



**“Document on Demand” (DOD) Search**

Viking wants to make it easy for you to get the product information you need, so we’ve added a new search to our website called “Document On Demand” (DOD). All Viking catalogs and literature have “Fax Back Numbers” to allow information to be faxed to you through our automated system, now the same numbers can be entered on our homepage for a direct link to product cut sheets.

ONE number, TWO easy ways to get information: **Online or FaxBack**

**How to Connect a Viking Door/Gate Entry System to Your Existing Phones**

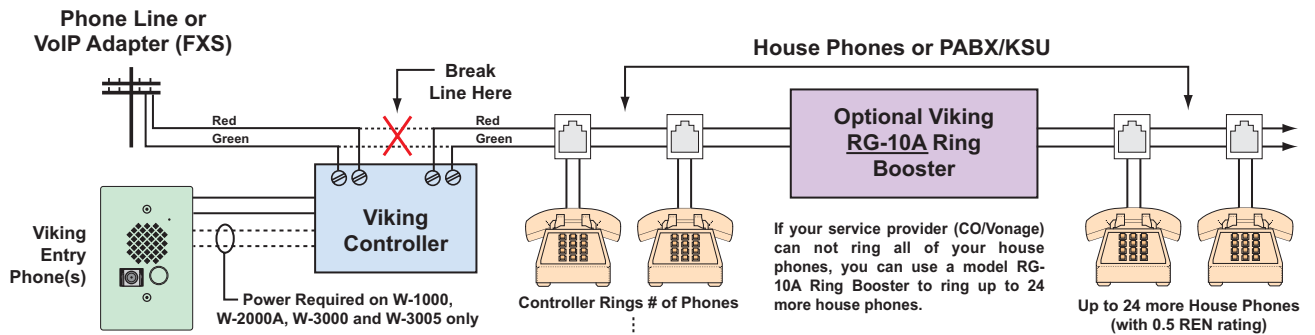

Entry Phones / Doorboxes	Use Controller	Maximum # Door Phones	Maximum # Doorstrikes	Entry Phone Caller ID	Keyless Entry	Controller Rings # of 0.5 REN House Phones
E-10A, E-20B, E-30, E-35*, E-40, E-50*	C-200	1	0	No	No	7
E-10A, E-20B, E-30, E-35*, E-40, E-50*,	C-2000A	4	4	Yes	No	16
K-1700-3, K-1705-3*, K-1900-8	C-2000A	4	4	Yes	Yes	16
W-1000, W-2000A, W-3000, W-3005*	C-1000B	2	2	No	No	14

\* Includes a built-in CCTV color camera, which requires additional wiring.

## Compact Handsfree Entry Phones

### Phone Line / VoIP Adapter Powered Door Entry Phones with Consumer Styling - Commercial Quality

- Two-wire installation and extended temperature range (-30°F to 150°F)
- Compact size for flush mounting in a single gang box (with minimum inside dimensions of: 2"W x 2.84"H x 2.25"D)
- Weather and vandal resistant for outdoor locations
- Auto disconnect on CPC, busy, dial tone, or silence
- Available with color video camera, see E-50 (page 5)
- Optional Enhanced Weather Protection (page 7)
- Dimensions: 3.12"W x 4.87"H x 1.7"D
- VE-3x5 surface mount box available (see page 10)
- PNL40 replacement faceplates available in 5 finishes



Model	Description	DOD#	Standard	EWP
E-40-SS	Stainless Steel Entry Phone	187	\$190.00	\$310.00
E-40-BN	Oil Rubbed Bronze Entry Phone	187	\$210.00	\$330.00
E-40-PB	Polished Brass Entry Phone	187	\$210.00	\$330.00
E-40-WH	Satin White Entry Phone	187	\$210.00	\$330.00
E-40-BK	Textured Satin Black Entry Phone	187	\$210.00	\$330.00

Use with these Viking controllers:

- C-200 (page 8)
- C-2000A (page 8)

## Handsfree Entry Phones with Built-In Auto Dialer

### Phone Line / VoIP Adapter Powered Phones Dial Pre-programmed Numbers

- Two-wire installation
- If the call is not answered, the E-30 will dial up to 4 more numbers
- E-30-PT has a push-to-talk button
- Vandal resistant, stainless steel faceplate with heavy-duty metal call button
- Non-volatile memory (no batteries required)
- Available with CCTV camera, see E-35 (page 5)
- Auto-disconnects on CPC, silence, busy signal, dial tone, time out or a touch tone command
- Programmable to auto-answer on incoming calls
- Extended temperature range (-30°F to 150°F)
- Optional Enhanced Weather Protection (page 7)
- Dimensions: 5"W x 5"H x 2.2"D

Use with these Viking controllers:

- C-200 (page 8)
- C-2000A (page 8)

E-30 & E-30-PT shown in optional VE-5x5 surface mount box (page 10)



Model	Description	DOD#	Standard	EWP
E-30	Flush Mount Entry Phone	212	\$201.00	\$321.00
E-30-PT	Entry Phone with Push to Talk	214	\$235.00	\$355.00

## Handsfree Entry Phones

### Phone Line / VoIP Adapter Powered Phones for Parking Ramps, Campuses and Door / Gate Entry

- Two-wire installation
- Auto-disconnects on CPC, silence, busy or dial tone
- Optional Enhanced Weather Protection (EWP) available
- Adjustable microphone and speaker volume
- Selectable auto-answer feature for remote monitoring
- Weather resistant features: mylar speaker, gaskets, internally sealed push button switch, UV stable exterior, enamel coated PCB
- Alternate action call button to place or cancel a call
- Surface mount box available for E-10A, model VE-5x5 (see page 10)
- E-10A dimensions: 5"W x 5"H x 2.2"D
- E-20B dimensions: 5.5"W x 4.5"H x 1.5"D

Use with these Viking controllers:

- C-200 (page 8)
- C-2000A (page 8)



Model	Description	DOD#	Standard	EWP
E-10A	Flush Mount Entry Phone	210	\$122.00	\$242.00
E-20B	Surface Mount Entry Phone	210	\$122.00	\$242.00

## Handsfree Entry Phone with Keypad

Phone Line / VoIP Adapter Powered For Keyless Door and Gate Entry or Apartment Applications

- Vandal Resistant Features: 14 gauge, louvered, stainless steel faceplate with stainless steel speaker/mic screen, heavy duty metal keypad and "Call" button
- Available in two standard finishes: brushed stainless steel or oil rubbed bronze
- Optional Enhanced Weather Protection (EWP) available (see page 7)
- Available with color video camera, see model K-1705-3 (page 5)
- Advanced call progress detection: disconnects on busy signal, return to dial tone, CPC, reorder tone, maximum call time out and selectable silence time out
- Extended temperature range (-20°F to 130°F)
- Dimensions: 6.5"W x 5.5"H x 2.6"D



K-1700-3



K-1700-3-BN

Use with these Viking controllers:

- C-200 (page 8)
- C-2000A (page 8)
- C-3000 (page 8)
- C-4000 (page 9)
- K-1900-3 (page 9)

Model	Description	DOD#	Standard	EWP
K-1700-3	Stainless Steel Phone with Keypad	157	\$304.00	\$450.00
K-1700-3-BN	Oil Rubbed Bronze Phone with Keypad	157	\$329.00	\$475.00

## Handsfree Doorboxes

Provides 24 Volt Talk Battery and 20 Hz Ring Generator for Phone System Unused Line Input Applications

- W-1000 Features: Flush mount, vandal resistant, black powder painted, aluminum face plate with heavy duty metal call button, mounting gasket and rough-in box
- W-2000A Features: Light gray colored, impact resistant, U.V. stable, plastic surface mount chassis
- Optional Enhanced Weather Protection (EWP) (see page 7)
- Extended temperature range (-15°F to 130°F)
- High output speaker amplifier with volume adjustment
- Microphone and speaker volume adjustments
- Selectable number of rings (2, 3, 10 or 30)
- Surface mount box available for W-1000, model VE-5x5 (see page 10)
- W-1000 dimensions: 5"W x 5"H x 2.2"D
- W-2000A dimensions: 5.5"W x 4.5"H x 1.5"D

Use with this Viking controller:

- C-1000B (page 8)



W-1000



W-2000A

Model	Description	DOD#	Standard	EWP
W-1000	Flush Mount Doorbox	170	\$143.00	\$263.00
W-2000A	Surface Mount Doorbox	170	\$143.00	\$263.00

## Stainless Steel Handsfree Doorbox

Provides 24 Volt Talk Battery and 20 Hz Ring Generator for Phone System Unused Line Input Applications

- Vandal resistant, 14 gauge stainless steel faceplate, heavy-duty metal push button and mounting gasket
- W-3005 has built-in color CCTV camera (see page 5 for complete camera specifications)
- Flush mount using the included rough-in box
- Selectable "Push-to-Talk" feature for noisy environments
- Extended temperature range (-15°F to 130°F)
- Yellow call progress/night light LED
- Optional Enhanced Weather Protection (EWP) (see page 7)
- High output speaker amplifier with volume adjustment
- Microphone and speaker volume adjustments
- Selectable distinctive ring (standard or 2 short rings)
- Selectable number of rings (2, 3, 10 or 30)
- Compact 45° terminal strip for easy wiring
- Dimensions: 5"W x 5"H x 2.2"D

Use with this Viking controller:

- C-1000B (page 8)



W-3005



W-3000

W-3000 & W-3005 shown in optional VE-5x5 surface mount box (page 10)

Model	Description	DOD#	Standard	EWP
W-3000	Stainless Steel Doorbox	180	\$170.00	\$290.00
W-3005	Stainless Steel Video Doorbox	181	\$370.00	\$490.00

## Camera Specifications

Viking video products have a built-in compact color composite video camera, see the complete specifications below. The camera is also available separately, see model VCAM-1.

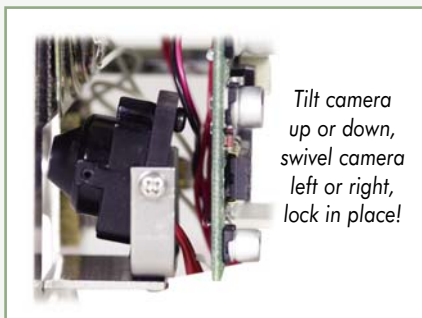

Tilt camera up or down, swivel camera left or right, lock in place!

- Color composite video output for versatility: 1 VP-P composite, NTSC, 75 ohms
- Extreme temperature rating: -40° to 185°F
- Wide 70° viewing angle
- Tilt/Swivel adjustment: vertical +/- 20°, horizontal +/- 30°
- Resolution: 420 lines (640 x 480 / 307,200 pixels)
- Sensitivity: 0.26 LUX (20 IRE) F2.0
- Lens: 3.4mm, pinhole 70°FOV
- Maximum wire run length: 150ft on CAT5E, 1000 ft with RG59 and CAT5

## Compact Color Video Camera Kit



- Stainless steel mounting hardware
- Potted circuit board
- 6V DC adapter/wire connections
- Tilt and swivel adjustment

Model	DOD#	Price
VCAM-1	190	\$235.00

## 5 Easy Ways

to integrate your video entry phones with your home TV sets!

Check out DOD# 886

## Handsfree Video Speaker Phone



- See E-30 for complete specifications on page 3
- Available with EWP (page 7) • Optional VE-5x5 (page 10)

Model	Description	DOD#	Price
E-35	Video Speaker Phone	178	\$401.00
E-35-EWP	E-35 with EWP	178	\$521.00

## Video Entry Phones



- See E-40 complete specifications on page 3
- Also available with Enhanced Weather Protection (see page 7)

Model	Description	DOD#	Price
E-50-SS	Video Speaker Phone	191	\$379.00
E-50-BN, PB, BK, WH	Video Speaker Phone	191	\$399.00
E-50-SS-EWP	EWP Version	191	\$499.00
E-50-BN, PB, BK, WH-EWP	EWP Version	191	\$519.00

## Accessible Video Entry System



- See AES-2000 for complete specifications on page 6
- Available in flush or surface mount styles

Model	Description	DOD#	Price
AES-2005F	Flush mount AES-2005	202	\$2595.00
AES-2005S	Surface mount AES-2005	202	\$2495.00

## 12-Button Video Entry Phone



- See K-1200 for complete specifications on page 6
- Shown in optional VE-5x10-SS surface mount box (page 10)
- Also available with Enhanced Weather Protection (see page 7)

Model	Description	DOD#	Price
K-1205	Multi-Button Entry Phone	183	\$695.00
K-1205-EWP	K-1205 with EWP	183	\$815.00

## Video Entry Phone with Keypad



- See K-1700-3 for complete specifications on page 4
- Available with EWP (page 7) • Optional VE-6x7 (page 10)

Model	Description	DOD#	Price
K-1705-3	Video Entry Phone	159	\$504.00
K-1705-3-EWP	K-1705 with EWP	159	\$624.00
K-1705-3-BN	Oil Rubbed Bronze	159	\$529.99
K-1705-3-BN-EWP	K-1705-3-BN EWP	159	\$649.00

## Handsfree Video Doorbox



- See W-3000 for complete specifications on page 4
- Available with EWP (page 7) • Optional VE-5x5 (page 10)

Model	Description	DOD#	Price
W-3005	Video Doorbox	181	\$370.00
W-3005-EWP	W-3005 with EWP	181	\$490.00

## Multi-Button Handsfree Entry Phone

Total Stand Alone Door Entry Solution Services up to 12 Apartments or Offices

- One button operation - just press the button associated with the tenant
- 12 speed dial buttons and 12 alternate numbers (22 digits each)
- K-1205 has built-in color CCTV camera (see page 9 for complete specifications)
- Integral directory with tenant's name beside each button
- The tenant can "Buzz" the visitor in from a phone, the K-1200 has an internal door strike relay
- 50 keyless entry codes and postal lock input
- Use with Viking C-3000 controller for "no-phone-line" operation
- Use with Viking SRC-1 controller for added security
- Optional Enhanced Weather Protection (EWP) (see page 7)
- Rough-in box included
- Blocks hand held touch tone dialers
- Connect to standard phone or PABX line
- Dimensions: 5" x 10" x 2.5"

Compatible with these optional Viking controllers:

- C-1000B (page 8)
- C-3000 (page 8)
- SRC-1 (page 9)



K-1200 and K-1205 shown in optional VE-5x10-SS surface mount box (page 10)

Model	Description	DOD#	Standard	EWP
K-1200	Multi-Button Entry Phone	182	\$495.00	\$615.00
K-1205	Multi-Button Video Entry Phone	183	\$695.00	\$815.00

## Apartment Entry System with Accessibility Features

Provide Both Audio and Visual Assistance for those with Disabilities

- 16-position, back-lit display with 1/2" tall characters
- Available with built-in color CCTV camera, model AES-2005 (page 5)
- Supports 525 tenant names and phone numbers
- Non-volatile data memory for names, phone numbers and access codes
- TTY jack for connection to personal teletypewriter (TTY)
- Available in surface mount (AES-2000S) or flush mount (AES-2000F)
- Extended temperature range (-15°F to 130°F)
- Keyless entry capability and postal lock switch input
- 5 Amp door strike/magnetic lock control relays
- Vandal resistant features:
  - 12 gauge stainless steel front panel with lock
  - 1/4" thick abrasion resistant polycarbonate display lens
  - Metal keypad and push button switches
- Weather resistant features:
  - Conformal coated circuit board
  - Gasketing behind lens, speaker, and keypad
  - Sealed switches and keypad

Compatible with these Viking products:

- HID-1 (page 11)
- HID-2 (page 11)
- PROXCARD (page 11)



AES-2000S shown

Model	Description	DOD#	Price
AES-2000S	Surface Mount Accessible Entry System	202	\$2195.00
AES-2000F	Flush Mount Accessible Entry System	202	\$2295.00

## Vandal Resistant Panel Phone

Attractive Vandal Resistant Hot Line Panel Phone with Built-In Keypad

- Auto-dials (up to 32 digits) programmable speed dial number
- Touch tone or pulse dialing with a programmable pre-dial pause
- K-1900-8 has a vandal resistant sealed metal keypad
- Vandal resistant 1/8" thick stainless steel panel, armored cable and metal cradle
- Optional Enhanced Weather Protection (EWP) (see page 7), EWP models have 54" armored cord
- Hearing aid compatible amplified handset with sealed push button volume control
- Optional surface mount box available, model VE-5x10 (see page 10)
- Dimensions: 5"W x 10"H x 4"D

Use with these Viking controllers:

- C-2000A (page 8)
- C-3000 (page 8)
- K-1900-3 (page 9)

K-1900-8 shown in optional VE-5x10 surface mount box (page 10)



Model	Description	DOD#	Standard	EWP
K-1900-8	Hot Line Panel Phone with Keypad	362	\$401.00	\$521.00

## What is Enhanced Weather Protection?

To protect against harsh outdoor environments, EWP product electronics (circuit boards, switches, trim pots, etc.) are enclosed in a "cocoon" of flexible urethane. EWP speakers are mylar. The EWP process seals out the elements, providing a long operating life for products installed in exposed locations. EWP products conform to NEMA (National Electrical Manufacturers Association) 3R requirements.

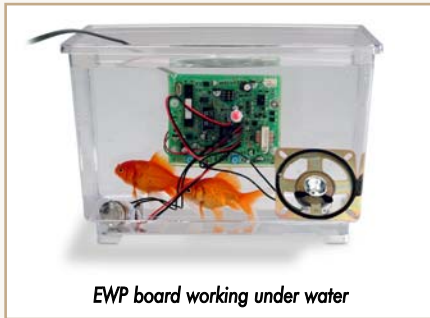

EWP board working under water

### Features

- Sealed switch, LED, trim pots, push button and microphone connections
- All wires are hand soldered
- Mylar speaker with special weatherproof boot
- Field adjustable trim pots and DIP switches
- Closed cell foam gasketing to prevent water penetration
- Weatherproof connectors filled with anti-corrosive gel



Tough and durable urethane potting

### Applications

- Exposure to harsh elements (outdoor emergency or entry phones)
- High-humidity environments (tropical environments and areas where it gets hot and humid)
- Corrosive atmosphere environments, salt air
- High pollution environments
- High vehicle exhaust environments (roadside assistance and parking garages)

## Does my installation require EWP?

If any of the following statements are "true" for your product application, we recommend a Viking product with Enhanced Weather Protection:

- Outside near the ocean
- Full weather exposure
- In a parking garage / ramp
- Near a swimming pool
- On a dock or pier.
- In a corrosive atmosphere
- Temperature gets below dew point



E-1600A-BLT-EWP



K-1200-EWP



E-1600-TP-EWP



E-1600A-EWP



K-1700-3-EWP



E-50-SS-EWP



E-35-EWP



E-50-SS-EWP



E-1600-60A-EWP

Model	Description	DOD#	Price
BLK-3-EWP	Blue Strobe Light Kit	653	\$150.00
E-1600A-EWP	Red Emergency Phone	215	\$366.00
E-1600-20A-EWP	Two-Button Emergency Phone	215	\$422.00
E-1600-45A-EWP	Yellow Emergency Phone	215	\$366.00
E-1600-03B-EWP	Stainless Steel Emergency Phone	215	\$570.00
E-1600-30A-EWP	Stainless Steel Emergency Phone	215	\$388.00
E-1600-50A-EWP	No-Chassis Emergency Phone	215	\$315.00
E-1600-52A-EWP	No-Chassis Emergency Phone	215	\$339.00
E-1600-55A-EWP	Custom Emergency Phone Kit	215	\$329.00
E-1600-60A-EWP	Blue Emergency Phone	215	\$366.00
E-1600A-BLT-EWP	Strobe Light Tower Phone	217	\$1025.00
E-1600ABLT2EWP	Two Button Tower Phone	217	\$1125.00
E-1600-TP-EWP	Talk-A-Phone Replacement	218	\$542.00
E-10A-EWP	Speaker Phone	210	\$242.00
E-20B-EWP	Speaker Phone	210	\$242.00
E-30-EWP	Speaker Phone	212	\$321.00
E-35-EWP	Video Speaker Phone	178	\$521.00
E-40-SS-EWP	Compact Entry Phone	187	\$310.00
E-40-BN/WH/PB/BK-EWP	Compact Entry Phone	187	\$330.00
E-50-SS-EWP	Compact Video Entry Phone	191	\$499.00
E-50-BN/WH/PB/BK-EWP	Compact Video Entry Phone	191	\$519.00
K-1200-EWP	12 Button Entry Phone	182	\$615.00
K-1205-EWP	12 Button Video Entry Phone	183	\$815.00
K-1700-3-EWP	Keypad Door Phone	157	\$450.00
K-1700-3-BN-EWP	Bronze Keypad Door Phone	157	\$475.00
K-1705-3-EWP	Video Keypad Door Phone	159	\$624.00
K-1705-3-BN-EWP	Bronze Video Keypad Phone	159	\$649.00
K-1900-7-EWP	Stainless Steel Panel Phone	360	\$376.00
K-1900-8-EWP	Panel Phone with Keypad	362	\$521.00
W-1000-EWP	Doorbox	170	\$263.00
W-2000A-EWP	Doorbox	170	\$263.00
W-3000-EWP	Doorbox	180	\$290.00
W-3005-EWP	Video Doorbox	181	\$490.00

EWP - Enhanced Weather Protection

### Single Entry Phone Controller

Allows Your House Phones or Phone System to Share a Phone Line / VoIP Adapter with a Single Viking Entry Phone

- House phones ring with C.O. line cadence or distinctive ring when the entry phone "Call" button is pressed
- Add an entry phone to your standard home or office phones
- Provide entry phone activated chimes and whole house paging when used with an SLP-1 or SLP-4 Paging Controller (page 11)
- Produces double "Call Waiting" tones
- One set of normally open and normally closed auxiliary contacts available
- **Coming Soon: Model C-210 (DOD# 174)**

Compatible with these Viking entry phones:

- E-10A (page 3)
- E-20B (page 3)
- E-30 (page 3)
- E-35 (page 5)
- E-40 (page 3)
- E-50 (page 5)



Model	Description	DOD#	Price
C-200	Single Entry Phone Controller	169	\$149.00

### Door or Gate Doorbox & CCTV Camera Controller

Allows Your Residential or Business Phone System to Share a Phone Line / VoIP Adapter with 2 Viking Doorboxes

- Doorbox triggered CCTV camera switching
- House phones ring with C.O. line cadence or distinctive ring when the entry phone "Call" button is pressed
- Provides two touch tone controlled N.O. or N.C. dry contacts

Compatible with these Viking doorboxes:

- W-1000 (page 4)
- W-2000A (page 4)
- W-3000 (page 4)
- W-3005 (page 5)



Model	Description	DOD#	Price
C-1000B	Doorbox & CCTV Controller	168	\$165.00

### Advanced Door or Gate Entry Phone Controller

Allows Your House Phones or Phone System to Share a Phone Line / VoIP Adapter with up to 4 Viking Entry Phones

- House phones ring with C.O. line cadence or distinctive ring when the entry phone "Call" button is pressed
- Provide entry phone activated chimes and whole house paging when used with Viking model SLP-1 or SLP-4 (page 11)
- Up to 6 different keyless entry codes / "one time use" keyless entry codes per entrance
- Up to 6 master keyless entry codes
- One set of normally open and normally closed contacts available for each entry phone
- Auxiliary input to activate timed auxiliary contacts

Compatible with these Viking entry phones:

- E-10A/E-20B (page 3)
- E-30/E-40 (page 3)
- E-35 (page 5)
- E-50 (page 5)
- K-1700-3 (page 4)
- K-1705-3 (page 5)

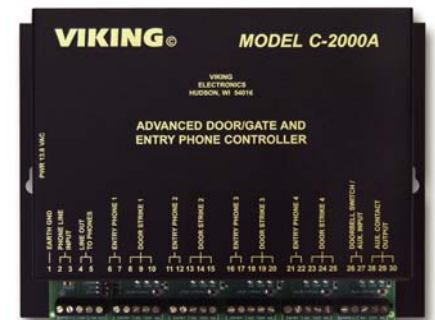

Model	Description	DOD#	Price
C-2000A	Advanced Entry Phone Controller	156	\$308.00

### No CO Line Apartment Entry System

Each Controller Services 12 Apartments

- Functions with or without tenant CO lines
- 12-tenant capacity may be expanded to 96 tenants at any time
- Supports two entry doors and doorstrikes, four Wiegand card readers
- Programmable keyless entry codes for each tenant
- Programmable from a local or remote touch tone phone or a PC

Compatible with these Viking entry phones:

- K-1200 (page 6)
- K-1205 (page 6)
- K-1700-3 (page 4)
- K-1705-3 (page 5)
- K-1900-8 (page 6)



Model	Description	DOD#	Price
C-3000	Apartment Entry Controller	162	\$495.00



## Apartment / Office Entry Controller

Provide 4 Door Entry Points with Keyless Entry or Optional Card Readers for up to 250 Apartments or Offices

- RS-232 Port for programming via a PC
- Supports 4 entry points and 4 Wiegand type card readers
- Stores 250 tenant Touch Tone phone numbers and 250 entry codes
- Programmable Master entry code & Maintenance Personnel entry codes
- Normally open and normally closed relay contacts for controlling door strikes, magnetic locks, gates, etc.

Compatible with these Viking entry phones:

- K-1700-3 (page 4)
- K-1705-3 (page 5)
- K-1900-8 (page 6)



Model	Description	DOD#	Price
C-4000	Apartment/Office Entry Controller	164	\$595.00

## Apartment / Office Door Entry Dialer

Provide Door Entry & Keyless Entry for up to 250 Apartments or Offices

- Stores 250 tenant touch tone phone numbers and keyless entry codes
- Programmable master keyless entry code and 5 maintenance codes
- Normally open and normally closed relay contacts for controlling door strikes, magnetic locks, gates, etc.
- Touch tone and pulse dialing toll restriction

Compatible with these Viking entry phones:

- K-1700-3 (page 4)
- K-1705-3 (page 5)
- K-1900-8 (page 6)



Model	Description	DOD#	Price
K-1900-3	Apartment/Office Door Entry Dialer	312	\$195.00

## Secure Relay Controller

Securely Operate Contacts from a Remote Location

- Cannot be operated by a hand held dialer at door entry phone
- User touch tone programmable 1 or 2 digit entry code
- Non-volatile memory - retains programming during power outage
- Programmable allow / restrict for dialing from entry phone
- Programmable allow / restrict for Bypass Mode
- 6 digit programmable security code (to access programming)
- Switchable 32V talk battery for use with E, K or W entry phones
- Programmable relay activation time
- Operates on any 12-24V AC/DC power source
- LED's for power / relay activation

Compatible with these Viking entry phones:

- E-10A/E-20B (page 3)
- E-30/E-40 (page 3)
- E-35/E-50 (page 5)
- K-1500-7 (online)
- K-1900-7 (online)
- K-1900-8 (page 6)
- W-1000 (page 4)
- W-2000A (page 4)
- W-3000 (page 4)
- W-3005 (page 5)



Model	Description	DOD#	Price
SRC-1	Secure Relay Controller	176	\$145.00

## Panasonic Doorphone Station Adapter

Add Any Viking "E" Series Phone to a Panasonic Doorphone/Door Opener Card

- Interfaces in place of a Panasonic KX-T30865 or KX-T7775 doorphone
- All Panasonic doorphone/door station card programming options and features may still be used
- Superior audio performance

Compatible with these Viking entry phones:

- E-10A/E-20B (page 3)
- E-30/E-40 (page 3)
- E-35/E-50 (page 5)

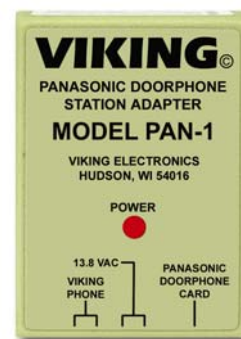

Model	Description	DOD#	Price
PAN-1	Panasonic Doorphone Station Adapter	145	\$65.00

### Vandal and Weather Resistant Surface Mount Boxes

The VE-Series surface mount boxes are black powder painted steel or stainless steel. They are designed to surface mount to a single gang electrical box, a gooseneck pedestal or to a wall. Compatible with these Viking products:



VE-3x5:	VE-5x5:	VE-6x7:	VE-5x10:
- E-40 - E-50	- E-10A - E-30 / E-35 - E-30-PT - E-1600-20A - E-1600-30A - W-1000 - W-3000	- K-1700-3 - K-1705-3	- K-1200 - K-1205 - K-1500-7 - K-1900-7 - K-1900-8

Model	Description	DOD#	Price
VE-3x5	Black Surface Mount Box	424	\$46.00
VE-5x5	Black Surface Mount Box	424	\$59.00
VE-6x7	Black Surface Mount Box	424	\$59.00
VE-5x10	Black Surface Mount Box	424	\$93.00

Model	Description	DOD#	Price
VE-5x5-SS	Stainless Steel Surface Mount Box	424	\$129.00
VE-6x7-SS	Stainless Steel Surface Mount Box	424	\$166.00
VE-5x10-SS	Stainless Steel Surface Mount Box	424	\$210.00

### Surface Mount Boxes with Panels

Viking's VE-PNL's are the perfect solution to the problem of mounting a switch, keypad or card reader to the outside of a building. Built from black powder painted steel or stainless steel, the back box provides durable enclosure required for outdoor applications. The blank front panel is made from aluminum, making it easy to drill, cut or form for the required mounting arrangement. The panel is straight lined and coated with a tough clear powder coating to resist corrosion. Four screws and a gas-ket are included to make installation a snap.

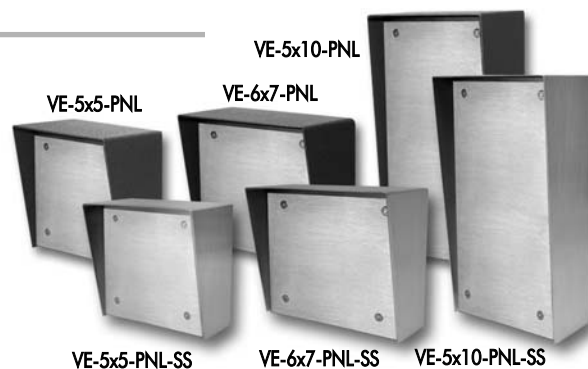

Model	Description	DOD#	Price
VE-5x5-PNL	Black Box with Panel	424	\$89.00
VE-6x7-PNL	Black Box with Panel	424	\$96.00
VE-5x10-PNL	Black Box with Panel	424	\$109.00

Model	Description	DOD#	Price
VE-5x5-PNL-SS	Stainless Steel Box with Panel	424	\$159.00
VE-6x7-PNL-SS	Stainless Steel Box with Panel	424	\$203.00
VE-5x10-PNL-SS	Stainless Steel Box with Panel	424	\$226.00

### Illuminate Your Door or Emergency Phone

The VE-Light kit adds bright LED illumination to any doorbox or entry phone that is housed in a Viking VE-5x5 or VE-6x7 surface mount box. The stainless steel bracket is easily mounted using existing holes and hardware.

VE-LIGHT shown alone below and in conjunction with the E-30 and VE-5x5 right



Model	DOD#	Price
VE-LIGHT	428	\$48.00

### Gooseneck Pedestals

The gooseneck pedestals are designed to be used with select Viking VE-Series surface mount boxes or VE-PNL surface mount panels. Ideal for drive up communications, the gooseneck pedestals are constructed of heavy duty black powder painted steel or stainless steel. Pad mount to a floor or concrete with 4 available bolt holes or use the VE-GNP-IG to mount in ground or wet cement.

Compatible with the following Viking products:

- VE-5x5 - VE-5x5-SS - VE-5x5-PNL - VE-5x5-PNL-SS
- VE-6x7 - VE-6x7-SS - VE-6x7-PNL - VE-6x7-PNL-SS
- VE-5x10 - VE-5x10-SS - VE-5x10-PNL - VE-5x10-PNL-SS

Model	Description	DOD#	Price
VE-GNP	42" Pad Mount Pedestal	424	\$117.00
VE-GNP-SS	42" Stainless Steel Pedestal	424	\$350.00
VE-GNP-IG	64" In-Ground Pedestal	424	\$117.00
VE-GNP-2	72" Double Pedestal	424	\$295.00



## Single Line Paging Controllers

Add Whole House Paging, Phone-to-Phone Intercom and Door Chimes to Your Audio System

- Stereo pre-amp input and line level output for whole house audio controllers
- Built-in two-watt mono paging amplifier with gain control
- Phone to phone intercom and place callers on music on hold while paging
- Can provide background music from an external source
- Selectable loud ringing and doorbell switch input
- Unique front and back door chimes when used with C-1000B or C-2000A
- Switch selectable On-Hold alarm tone
- Model SLP-4 comes pre-loaded with 8 CD quality chimes for up to 4 entrances or download your own wave files via the USB port



Compatible with these Viking controllers:

- C-200 (page 8)
- C-2000A (page 8)
- C-1000B (page 8)

Model	Description	DOD#	Price
SLP-1	Single Line Paging Controller	478	\$165.00
SLP-4	SLP-1 with Four Door Chimes	479	\$389.00

## Analog Telephone Adapter

Provide an IP Network Connection for Analog Telephone Devices

- Supports the following network protocols: SIP 2.0(RFC 3261), TCP/UDP/IP, RTP/RTCP, HTTP, ICMP, ARP, DNS, DHCP, NTP, PPPoE, STUN, TFTP, etc.
- Powerful digital signal processing (DSP) to ensure superb audio quality.
- Supports various codecs including G.711 (a-law and u-law), G.723.1 (5.3K/6.3K), and G.729A/B
- Supports out-of-band DTMF via RTP (RFC2833) or SIP INFO
- Supports Caller ID/Name display
- Supports Call Hold, Call Waiting/Flash, Call Transfer, Call Forward
- Supports device configuration via built-in IVR or Web browser



Model	Description	DOD#	Price
ATA-100	Analog Telephone Adapter	234	\$119.00

## ProxCard Products

Standard 26-Bit Wiegand Interface



HID-2

- HID-1: Potted enclosure with pigtail connection for indoor and outdoor applications
- HID-2: Potted aluminum housing for mullion mounting
- HID-2: Pigtail leads
- HID-2: Beeper and LED show status
- PROXCARD: No magnetic strip to wear out, no batteries needed
- PROXCARD: Credit card size



HID-1



PROXCARD

Model	Description	DOD#	Price
HID-1	Proximity Card Reader	197	\$130.00
HID-2	Wiegand Keypad	199	\$199.00
PROXCARD	Proximity Card	198	\$5.00

## Talk Battery Booster

Boost Talk Battery on Low Loop Current Lines

- Boost loop current up to 26mA
- Easy modular installation
- Power LED also displays activity
- Passes original ringing to the device
- Passes caller ID data
- Passes hook switch flash
- Passes CPC signals
- Compatible with touch tone dialing

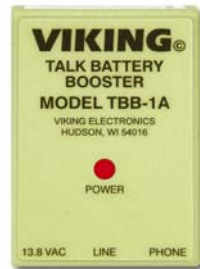

Model	Description	DOD#	Price
TBB-1A	Talk Battery Booster	630	\$69.00

## Ring Booster

Boosts Ring Voltage on Phone Lines or VoIP Adapters

- Ring up to 24 more 0.5 REN phones
- Caller ID compatible
- Modular installation
- Compatible with distinctive ring
- Will not affect normal line operation
- Reshapes troublesome square wave ringing



Model	Description	DOD#	Price
RG-10A	Ring Booster	420	\$150.00



## Commercial Quality

Viking Electronics knows how to design communications products that perform under all conditions - we've been doing it that way for over 35 years. Attention to detail is why commercial property managers and residential home owners alike depend on Viking products to perform, heat or cold, rain or shine.

## Affordable

We encourage you to compare the price, quality and features of our products to the competition. We know you'll find that when it comes to quality construction and reliability, Viking's communication products offer the best value.

## Consumer Styling

It's been hard to find commercial quality communications products styled for residential applications - until now. Viking's door entry phones sport an industry-first; single-gang compact footprint, making them the perfect choice for residential applications where mounting space is at a premium.

---

For a full-line product catalog, please contact Viking at 715-386-8861 or online: [www.vikingelectronics.com](http://www.vikingelectronics.com)

Viking products are in stock at the following distributors:

**Graybar**  
800-825-5517 • [www.graybar.com](http://www.graybar.com)

**ADI**  
800-233-6261 • [www.adilink.com](http://www.adilink.com)

**Anixter**  
800-323-8167 • [www.anixter.com](http://www.anixter.com)

**Jenne Distributing**  
800-422-6191 • [www.jenne.com](http://www.jenne.com)

**TeleDynamics Corporation**  
800-847-5629 • [www.teledynamics.com](http://www.teledynamics.com)

**Target Distributing**  
800-873-5528 • [www.targetdist.com](http://www.targetdist.com)

**Windstream Supply**  
800-533-3161 (US/CANADA)  
[www.windstreamsupply.com](http://www.windstreamsupply.com)

**Communications Supply**  
800-786-9584 • [www.gocsc.com](http://www.gocsc.com)

**Hall Telecommunications**  
519-822-5420 • [www.halltel.com](http://www.halltel.com)  
800-265-2667 (CANADA)

**Capitol Sales**  
800-467-8255 • [www.capitolsales.com](http://www.capitolsales.com)

**Goldcom, Inc.**  
800-788-8848 • [www.Gold-com.com](http://www.Gold-com.com)

**NTD Distributors**  
800-426-1024 • [www.ShopNTD.com](http://www.ShopNTD.com)

**Power & Telephone**  
800-238-7514 • [www.ptsupply.com](http://www.ptsupply.com)

**High Tech Communication**  
800-256-3010 • [www.high-techcomm.com](http://www.high-techcomm.com)

**HB Distributors**  
800-266-3478 • [www.HBdistributors.com](http://www.HBdistributors.com)

**International Sales: Viking International**  
612-331-3823 • [www.vikingelectronics.com](http://www.vikingelectronics.com)

**Viking Electronics, Inc.**  
1531 Industrial Street  
Hudson, Wisconsin 54016  
Printed in the USA

PRSR STD  
U.S. POSTAGE  
PAID  
LA CROSSE, WI  
PERMIT NO. 25