

TECHNICAL Practice

TELECOM SOLUTIONS FOR THE 21ST CENTURY

AES-2000
Accessible Entry
System

April 27, 2018

Apartment Entry System with Accessibility Features



AES-2000S Surface Mount

The unit is available in flush (**AES-2000F**) and surface mount (**AES-2000S**) configurations and features a highly vandal resistant housing. The **AES-2000** will also support keyless entry at the door via its built-in keypad, or by adding Wiegand-type proximity card readers, such as the **Viking PRX-1, PRX-2, PRX-3, PRX-4, PRX-5, or LRR-4**.

The unit is available in flush (**AES-2000F**) and surface mount (**AES-2000S**) configurations and features a highly vandal resistant housing.

Note: The AES-2000 utilizes an internal modem for programming. This requires an analog phone line or VoIP line with a high quality network connection and non-compressing codec. See Page 5.



AES-2000F Flush Mount

Features

- 16 position, back-lit display with 1/2" tall characters
- Non-volatile digital voice announcer
- Factory configured to voice announce the names for 75 apartments (expandable to 525 apartments using **ERAM-4M** expansion kits, see **DOD 854**)
- Non-volatile data memory for names, phone numbers and access codes
- Volume control
- AES-NET card reader interface included
- TTY jack for connection to personal teletypewriter (TTY)
- Postal lock switch input
- Available in surface mount (**AES-2000S**) or flush mount (**AES-2000F**) configurations
- Keyless entry capability
- 5 Amp door strike/magnetic lock control relays
- **Vandal resistant features:**
 - 12 gauge stainless steel front panel
 - 1/4" thick abrasion resistant polycarbonate display lens
 - Metal keypad and push button switches
 - Front panel lock
 - Speaker protection screen
- **Weather resistant features:**
 - Enamel coated circuit board
 - Gasketing behind lens, speaker, keypad and perimeter of front panel
 - Sealed switches and keypad

Applications

- High rise apartment buildings
- Condos
- Senior citizen buildings
- Assisted care centers
- Retirement homes
- Gated communities
- Use with Viking **PRX-1 (DOD 221), PRX-2 (DOD 219), PRX-3 (DOD 228) or PRX-4 (DOD 199)** Proximity Card Readers

Specifications

Power: 120V AC/13.8V AC 1.25A, UL listed adapter provided
Dimensions: **AES-2000S** (Surface): 12.26" x 9.66" x 4.25" (311.4mm x 245.36mm x 107.9mm), **AES-2000F** (Flush): 15.1" x 12.6" x 3.25" (383.5mm x 320mm x 82.55mm)
Shipping Weight: 17 lbs (7.7kg)
Environmental: -15° F to 130° F (-26° C to 54° C) with 5% to 95% non-condensing humidity (see **Installation** for details)
Display: 16 position, 0.5" x 4.25" back-lit LCD
Relay Contacts: 5A @ 30V DC/250V AC maximum
Connections: (20) cage clamp screw terminals
Maximum Wiegand Length (24 AWG wire): **PRX-1:** 800 ft (244m), **PRX-2:** 400 ft (122m), **PRX-3** (using 3 pairs for power): 800 ft (244m), **PRX-4:** 800 ft (244m)

IF YOU HAVE A PROBLEM WITH A VIKING PRODUCT, PLEASE CONTACT: VIKING TECHNICAL SUPPORT AT (715) 386-8666

Our Technical Support Department is available for assistance Monday 8am - 4pm and Tuesday - Friday 8am - 5pm central time. So that we can give you better service, before you call please:

1. Know the model number, the serial number and what software version you have (see serial label).
2. Have your Technical Practice in front of you.
3. It is best if you are on site.

RETURNING PRODUCT FOR REPAIR

The following procedure is for equipment that needs repair:

1. Customer must contact Viking's Technical Support Department at 715-386-8666 to obtain a Return Authorization (RA) number. The customer MUST have a complete description of the problem, with all pertinent information regarding the defect, such as options set, conditions, symptoms, methods to duplicate problem, frequency of failure, etc.
2. Packing: Return equipment in original box or in proper packing so that damage will not occur while in transit. Static sensitive equipment such as a circuit board should be in an anti-static bag, sandwiched between foam and individually boxed. All equipment should be wrapped to avoid packing material lodging in or sticking to the equipment. Include ALL parts of the equipment. C.O.D. or freight collect shipments cannot be accepted. Ship cartons prepaid to: **Viking Electronics, 1531 Industrial Street, Hudson, WI 54016**
3. Return shipping address: Be sure to include your return shipping address inside the box. We cannot ship to a P.O. Box.
4. RA number on carton: In large printing, write the R.A. number on the outside of each carton being returned.

RETURNING PRODUCT FOR EXCHANGE

The following procedure is for equipment that has failed out-of-box (within 10 days of purchase):

1. Customer must contact Viking's Technical Support at 715-386-8666 to determine possible causes for the problem. The customer MUST be able to step through recommended tests for diagnosis.
2. If the Technical Support Product Specialist determines that the equipment is defective based on the customer's input and troubleshooting, a Return Authorization (R.A.) number will be issued. This number is valid for fourteen (14) calendar days from the date of issue.
3. After obtaining the R.A. number, return the approved equipment to your distributor, referencing the R.A. number. Your distributor will then replace the product over the counter at no charge. The distributor will then return the product to Viking using the same R.A. number.
4. **The distributor will NOT exchange this product without first obtaining the R.A. number from you. If you haven't followed the steps listed in 1, 2 and 3, be aware that you will have to pay a restocking charge.**

TWO YEAR LIMITED WARRANTY

Viking warrants its products to be free from defects in the workmanship or materials, under normal use and service, for a period of two years from the date of purchase from any authorized Viking distributor. If at any time during the warranty period, the product is deemed defective or malfunctions, return the product to Viking Electronics, Inc., 1531 Industrial Street, Hudson, WI., 54016. Customer must contact Viking's Technical Support Department at 715-386-8666 to obtain a Return Authorization (R.A.) number.

This warranty does not cover any damage to the product due to lightning, over voltage, under voltage, accident, misuse, abuse, negligence or any damage caused by use of the product by the purchaser or others. This warranty does not cover non-EWP products that have been exposed to wet or corrosive environments. This warranty does not cover stainless steel surfaces that have not been properly maintained.

NO OTHER WARRANTIES. VIKING MAKES NO WARRANTIES RELATING TO ITS PRODUCTS OTHER THAN AS DESCRIBED ABOVE AND DISCLAIMS ANY EXPRESS OR IMPLIED WARRANTIES OR MERCHANTABILITY OR FITNESS FOR ANY PARTICULAR PURPOSE.

EXCLUSION OF CONSEQUENTIAL DAMAGES. VIKING SHALL NOT, UNDER ANY CIRCUMSTANCES, BE LIABLE TO PURCHASER, OR ANY OTHER PARTY, FOR CONSEQUENTIAL, INCIDENTAL, SPECIAL OR EXEMPLARY DAMAGES ARISING OUT OF OR RELATED TO THE SALE OR USE OF THE PRODUCT SOLD HEREUNDER.

EXCLUSIVE REMEDY AND LIMITATION OF LIABILITY. WHETHER IN AN ACTION BASED ON CONTRACT, TORT (INCLUDING NEGLIGENCE OR STRICT LIABILITY) OR ANY OTHER LEGAL THEORY, ANY LIABILITY OF VIKING SHALL BE LIMITED TO REPAIR OR REPLACEMENT OF THE PRODUCT, OR AT VIKING'S OPTION, REFUND OF THE PURCHASE PRICE AS THE EXCLUSIVE REMEDY AND ANY LIABILITY OF VIKING SHALL BE SO LIMITED.

IT IS EXPRESSLY UNDERSTOOD AND AGREED THAT EACH AND EVERY PROVISION OF THIS AGREEMENT WHICH PROVIDES FOR DISCLAIMER OF WARRANTIES, EXCLUSION OF CONSEQUENTIAL DAMAGES, AND EXCLUSIVE REMEDY AND LIMITATION OF LIABILITY, ARE SEVERABLE FROM ANY OTHER PROVISION AND EACH PROVISION IS A SEPARABLE AND INDEPENDENT ELEMENT OF RISK ALLOCATION AND IS INTENDED TO BE ENFORCED AS SUCH.

FCC REQUIREMENTS

This equipment complies with Part 68 of the FCC rules and the requirements adopted by the ACTA. On the side of this equipment is a label that contains, among other information, a product identifier in the format US:AAAEQ##TXXXX. If requested, this number must be provided to the telephone company.

The REN is used to determine the number of devices that may be connected to a telephone line. Excessive REN's on a telephone line may result in the devices not ringing in response to an incoming call. In most but not all areas, the sum of the REN's should not exceed five (5.0). To be certain of the number of devices that may be connected to a line, as determined by the total REN's, contact the local telephone company. For products approved after July 23, 2001, the REN for this product is part of the product identifier that has the format US:AAAEQ##TXXXX. The digits represented by ## are the REN without a decimal point (e.g., 03 is a REN of 0.3). For earlier products, the REN is separately shown on the label.

The plug used to connect this equipment to the premises wiring and telephone network must comply with the applicable FCC Part 68 rules and requirements adopted by the ACTA. If your home has specially wired alarm equipment connected to the telephone line, ensure the installation of this AES-2000 does not disable your alarm equipment. If you have questions about what will disable alarm equipment, consult your telephone company or a qualified installer.

If the AES-2000 causes harm to the telephone network, the telephone company will notify you in advance that temporary discontinuance of service may be required. But if advance notice isn't practical, the telephone company will notify the customer as soon as possible. Also, you will be advised of your right to file a complaint with the FCC if you believe it is necessary.

The telephone company may make changes in its facilities, equipment, operations, or procedures that could affect the operation of the equipment. If this happens, the telephone company will provide advance notice in order for you to make the necessary modifications to maintain uninterrupted service.

If trouble is experienced with the AES-2000, for repair or warranty information, please contact:

Viking Electronics, Inc., 1531 Industrial Street, Hudson, WI 54016 (715) 386-8666

If the equipment is causing harm to the telephone network, the telephone company may request that you disconnect the equipment until the problem is resolved.

Connection to Party Line Service is subject to State Tariffs. Contact the state public utility commission, public service commission or corporation commission for information.

WHEN PROGRAMMING EMERGENCY NUMBERS AND (OR) MAKING TEST CALLS TO EMERGENCY NUMBERS:

Remain on the line and briefly explain to the dispatcher the reason for the call. Perform such activities in the off-peak hours, such as early morning or late evenings.

It is recommended that the customer install an AC surge arrester in the AC outlet to which this device is connected. This is to avoid damaging the equipment caused by local lightning strikes and other electrical surges.

PART 15 LIMITATIONS

This equipment has been tested and found to comply with the limits for a Class A digital device, pursuant to Part 15 of the FCC Rules. These limits are designed to provide reasonable protection against harmful interference when the equipment is operated in a commercial environment. This equipment generates, uses, and can radiate radio frequency energy and, if not installed and used in accordance with the instruction manual, may cause harmful interference to radio communications. Operation of this equipment in a residential area is likely to cause harmful interference in which case the user will be required to correct the interference at his own expense.

Installation

A. Flush Mount Chassis (AES-2000F)

The **AES-2000F** comes with a zinc-plated steel rough-in box and a black powder-painted steel mounting ring. The rough-in box is meant to be framed into the wall. Make sure the outer edge of the box is within 1/4 inch of the finished surface of the wall, but not protruding past the surface level. Knockouts are provided in the box to accommodate conduit entrance from the sides or bottom.

Important: The **AES-2000F** is rated to operate at temperatures up to 130 degrees Fahrenheit. If the unit is installed where it is exposed to direct sunlight, the front panel can exceed this maximum temperature. Above this specified maximum rating, the buttons will become hot for the tenants to press and the LCD display will go dark.

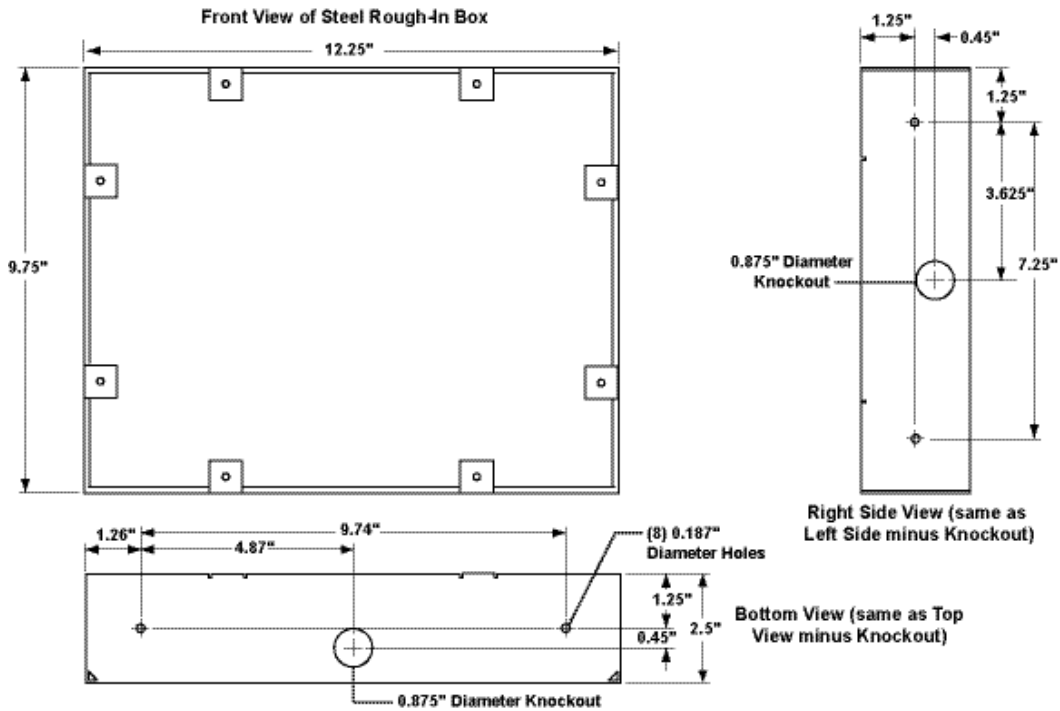

Step 1.	After the wall is finished, the mounting ring can be screwed to the rough-in box.
Step 2.	Once the mounting ring is secure, the front panel of the AES-2000S can be fastened to the ring using the 3 screws and nuts provided by aligning the hinge with the three holes on the right side of the frame. Note: Make sure the key lock is in the open position.
Step 3.	Insert the screws and tighten the nuts firmly. Note: Be careful not to damage the foam gasket around the back edge of the panel.

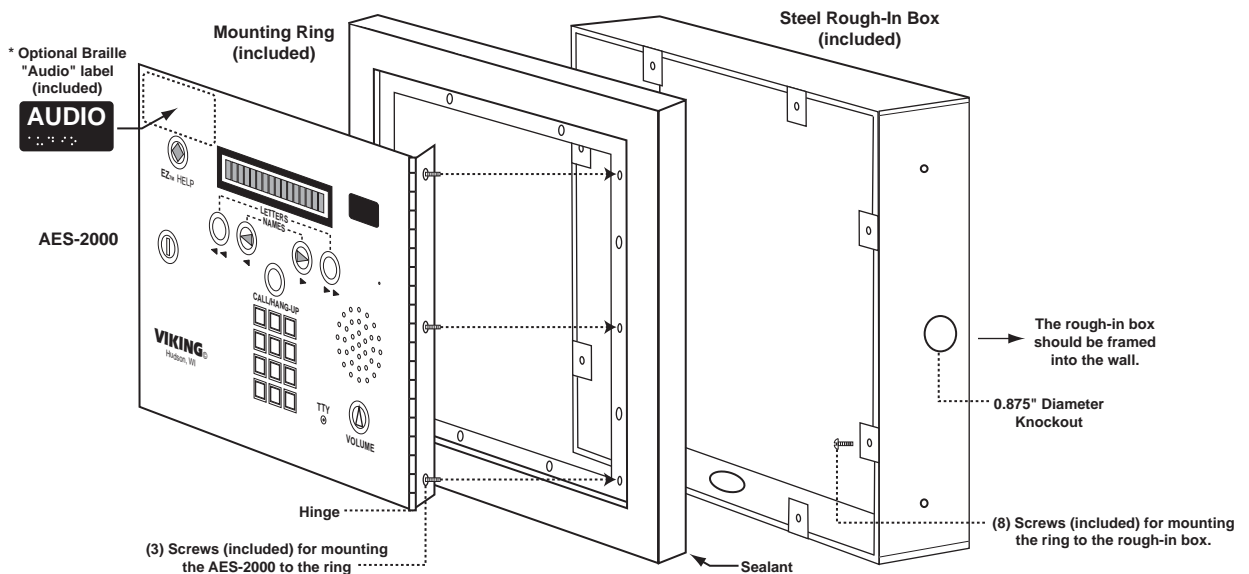

Important: If the enclosure is to be mounted outdoors, use an appropriate sealant around the outer edge of the mounting ring.
* **Note:** To help steer visually impaired visitors to the location of the **EZ™ HELP** button, the optional Braille "Audio" label may be adhered above the push button.

C. Wiring Connections

Two POTs are provided to increase or decrease speaker volume and microphone sensitivity. In certain noisy locations the speaker volume can be increased and the microphone sensitivity may need to be decreased as shown. **Caution:** Setting the microphone gain too high may cause distorted audio and prevent the distant party from breaking over.

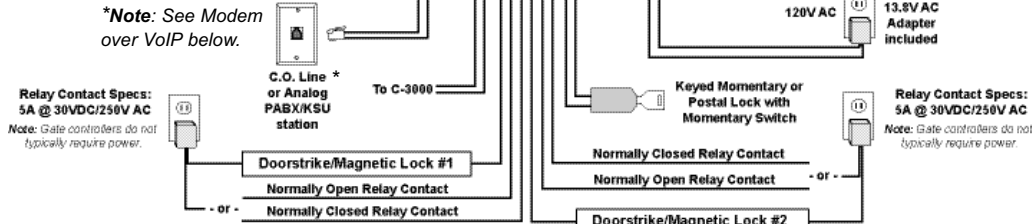

Once the **AES-2000** is secured to the wall, the unit can be connected to the building wiring as described below.

Step 1.	Cut off the 2.1 mm plug from the end of the AC power adapter cord. The AC adapter can be located up to 100 feet away from the entry system when using a minimum of 24 AWG wire.
Step 2.	Make all connections to the AES-2000 panel before inserting the adapter into a wall outlet. The two wires from the AC adapter connect to the two terminal block positions labeled "13.8 VAC".
Step 3.	If the incoming telephone line has an RJ-11 connector, connect it to the RJ-11 jack on the control board. Two terminal positions marked "C.O." are also provided for a striped wire connection. Note: See <i>Modem over VoIP</i> below.
Step 4.	The AES-2000 can be wired to operate a single door strike, or a door strike and an automatic door opener. The doorstrike and door strike power supply should be wired to the terminal positions labeled "Door Strike 1". Both normally open and normally closed contacts are available.
Step 5.	If your automatic door requires a contact closure for activation, wire it to the terminal positions labeled "Door Strike 2". Both normally open and normally closed contacts are available.
Step 6.	If the installation requires a postal lock, a normally open momentary key switch can be wired to the terminal block positions labeled "Postal Lock".
Step 7.	If a C-3000 is to be used, connect a pair of wires from the AES-2000 terminal block labeled "C-3000" to the C-3000 entry phone connection. The phone numbers for the lines wired to the C-3000 must have a "C" programmed as the first character (see Programming). For more information, see DOD# 162 and 868 .
Step 8.	After all the connections are made, close and lock the hinged panel.
Step 9.	The last step is to connect the A.C. power adapter to a wall outlet. When power is connected to the system, the front display should show "Welcome!"

Note: The doorstrike and door opener can be tested using the default keyless entry code programmed in the panel. Dial "#" + "00864" on the **AES-2000** keypad.

1. Modem over VoIP

If you are replacing an analog PSTN (Public Switched Telephone Network) or POTS (Plain Old Telephone Service) line with VoIP service, be aware that the following Viking models utilize internal modems for programming: **AES-2000**, **AES-2005**, **PB-100** and **CTG-2**.

The problem is that the codecs used by VoIP ATA's (Analogue Terminal Adapter) are designed to compress voice, not the analog signals sent and received by modems. A second problem is if a non-compressing codec is used, the transmission will be very sensitive to network QoS (Quality of Service), i.e. packet loss, jitter, and latency will be issues. To successfully use data modems over a VoIP connection you will need a minimum of:

- A non-compressing codec such as ITU G.711
- A high quality network connection

Programming

The tenant names and phone numbers must be programmed into the system for proper operation. This programming is done through the telephone line interface using the **PB-100** with special software. This allows either remote programming from a distant location, or local programming using the Viking **DLE-300** line simulator. The **PB-100** is connected to a serial port of a P.C. and Windows based software is used to enter tenant names, phone numbers and the recording for the voice directory. A data base is constructed for each apartment to make future changes easier. When the Remote Programmer software is first invoked, the screen at the right pops up. After a few seconds, the "Building Selection" screen will appear.

The following sections provide a brief overview of programming screen shots and descriptions. Detailed programming instructions are available only in the software itself.

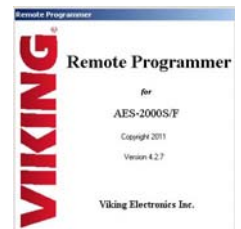

A. Building Selection

The Remote Programming Software is capable of handling information on many different buildings. The Building Selection screen (left) displays the information on each building. This screen also allows the user to add a new building, or drop an old one. Pressing the Next button will bring up the "Apartment Selection" screen.

The System Parameters pop up (right) (under the Setup menu) is used to set up the various programmable features of each entry system. Door strike timing, opener code, maximum call time, ring count and silence time out are all programmable from this screen. This screen also has a check box for disabling the Keyless Entry Codes. This feature is useful when using card readers. By checking this box, a card can be used to gain access, but trying to enter the card number as a keyless code will not work. To override this disable, just add a new tenant without any name, and only enter the keyless code in the Apartment Selection screen.

B. Apartment Selection

This screen (far right) is used to set up the information on each of the tenants in the building. New tenants can be added, and existing names and codes can be changed. When using card readers, the keyless entry code feature can be disabled in the system Parameters screen. If you want to have a code that can override this feature, enter a five digit code number in the Keyless Code box, but do not fill in any other boxes. That code can be used as a keyless code even though keyless codes have been disabled.

If the apartment phone line is wired through a Viking **C-3000**, the phone number field must start with a "C".

The list can be sorted according to name, apartment number, phone number, or code numbers by selecting the "Sort" pull down (near right). Clicking on the Back button will bring up the previous screen "Building Selection", clicking on the Next button will bring up the "Data Transmit" screen.

C. Transmitting Data to and from the AES-2000

After the **PB-100** dials the phone number of the **AES-2000** and creates a link, the AES Remote Screen (Statistic Info), then the Security Code screen will pop up. If the security code in the **AES-2000** is still the default value, enter "8,4,5,4,6,4". If the security code has changed from the default, enter the unique security code. Once in the Data Transmit screen, use the Security Code selection under the Tools pull down to change the security code. If this screen is left blank, no code will be required. Keep in mind that while the **PB-100** is linked to the **AES-2000**, ALL DOOR ENTRY FUNCTIONS ARE HALTED until the **PB-100** hangs up.

1. Data Transmit Screen

The Data Transmit screen (right) is used to control the transfer of information from the P.C. to the entry system. The data block size and the number of retries can be tailored to fit any phone line condition. The user has the option of sending all the records or just sending the records that have been modified in the previous screen by setting the "Show Changes Only" check off. If an **AES-NET** card installed in the **AES-2000** and a local card reader is used, the **AES-NET** can be programmed using the Local Card Reader selection of the Tools pull down. For more information on programming the local card reader, refer to the **AES-NET** Technical Practice. To go to the previous Apartment Selection screen, click on the Back button. To go on to the audio recording click on the Next button.

2. Download Names Screen

The Download Names screen (right) is used to retrieve the tenant names, phone numbers, access codes and keyless entry codes that have been previously programmed into the **AES-2000**. The "Present ID" box contains the ID number of the first record to be downloaded. The tenant ID is an unchangeable consecutive number assigned to the tenant when they were added to the database. The "Download Count" box contains the total number of records to be downloaded. Clicking on "Download" will retrieve all records starting with the "Present ID" through the Download Count. Once the records are displayed in the data field, the "File" pulldown menu can be used to print or save the data. Clicking on "Clear" will clear data fields and reset the present ID to 1. Clicking on "Back" will return the user to the Data Transmit Screen.

ID	Name	Phone Number	Speed Dial	Keyless Code
1	Anderson, F	2313421	*0##	123456
2	Aster, W	8452536	4443	738454
3	Duncan, M	5672757	5487	756345
4	Edgar, W	7653567	5273	724846
5	Frank, T	3860900	3800	387368
6	Gregory, P	5462468	1266	447799
7	Hanson, D	2165676	1265	539833
8	Inger, W	12345678	0023	12
9	Pear, S	6540877	0002	854801
10	Olsen, L	4327645	4543	326587
11	Pearson, W	5439989	3221	588699
12	Quincy, D	5460897	4351	656378

3. Download Statistics Screen

Date	Time	Name/Type	Code	Entry Point
10/14/02	11:29am	Tansonaskerdel, T	8659	Main
10/14/02	11:30am	Rasmusinkenden, V	Directory	Main
10/14/02	11:31am	Uesrspondinis, J	2164435	Main
10/14/02	11:31am	Wickersonski, Z	Card Entry	Main
10/14/02	11:31am	Keyless Code	#42423	Main
10/14/02	11:32am		Inward Call	Main
10/14/02	11:34am		Postal Lock	Main
10/14/02	11:34am	Wickersonski, Z	Card Entry	Main
10/14/02	11:34am	Rasmusinkenden, V	9810	Main
10/14/02	11:42am	Wickersonski, Z	Card Entry	L 7
10/14/02	11:42am	Wickersonski, Z	Card Entry	Main
10/14/02	11:42am	Wickersonski, Z	Card Entry	L 7

The Download Statistics screen (left) allows the user to retrieve the **AES-2000's** building entry log. Each time the **AES-2000** energizes the door strike, it adds to the log, recording the date, time name/type (tenant allowing the entry) and code (type of actuation). Up to 1024 entries can be stored before the oldest entry is written over. Retrieving just a portion of the log can be accomplished by entering a "Read Pointer" value for the starting point and a "Count" value for the ending point. To receive the **AES-2000's** existing data, click on "Download" and to clear all existing data click on "Reset". Clicking "Back" will return the user to the Data Transmit Screen.

4. Entry Points Screen

If remote **ES-3** modules are installed, the Entry Points screen (right) is used to program each **ES-3**. When this screen is invoked, fill in group and rotary switch setting for the **ES-3** that you wish to program. It is best to click on Get Status to retrieve the present settings. Any changes can be entered directly into the data boxes. For complete **ES-3** programming instructions, see the **ES-3** Technical Practice (DOD# 195).

D. Recordings

The Recordings screen (right) is used to make an audio recording of each of the names of the tenants. These are the recordings that a user will hear when the user is stepping through the directory of the **AES-2000**. When in the record mode, the software will step through each name, displaying it in large letters, and prompting the user as when to speak. After each recording is made, the software plays it back automatically, and selects the next name from the list. Completed recordings are listed in the box on the right hand side. To go back to the data mode, click on the Back button. To end the session, click on the Exit button.

To make a recording: Click record. The unit counts down 3, 2, 1 (1 beep heard in the phone). You now have 3 seconds to say the name, then two beeps are heard and the recording plays back. If three beeps are heard instead of one after the count down, you probably don't have enough ERAM. From the factory, the unit can record 75 names. Names with an ID of 76 or higher will give three beeps if no memory was added.

Programming the AES-NET Interface

The **AES-NET** interface, included with the **AES-2000**, allows a local Wiegand device such as a Proximity Card Reader to be added to the **AES-2000** accessible door entry system. Using Proximity cards instead of keyless entry codes, the building manager keeps control over the number of people that can let themselves into the building. The Wiegand device used may be the Viking model **PRX-1** Proximity Card Reader or any other card reader, RF transmitter, or digital keypad that outputs 26 bit Wiegand data.

In addition to a directly connected Wiegand device, the **AES-NET** interface also provides two wire CAN bus connections which supports up to 32 additional remote points of entry. Each additional remote entry point requires one Viking Model **ES-3** door controller, one Wiegand device, and a door strike or magnetic lock of your choice. Only one pair of wires are needed to wire all 32 entry system door controllers back to the **AES-NET** interface.

Specifications:

Maximum CAN length: 2600 ft (0.8 Km) using 24 AWG twisted pair, 1.6 Km (5300 ft) using 2 pairs of 24 AWG twisted pair

Maximum Wiegand Length: 800 ft (244m) - 24 AWG wire

Connections: Six cage clamp screw terminals

A. Definitions

26 bit Wiegand format: The industry standard data output of access control card readers.

CAN Communications: A highly reliable two wire communications protocol developed for the automotive industry.

Entry point: A door or gate allowing access into a secure or controlled area.

Proximity Card Reader: A device used to read the data from a Proximity Card when it's held within a few inches of the reader.

Facility Code: A 3-digit number that each proximity card contains in order to provide greater security. Usually the cards used at a given building all have the same facility code. By programming cards with different facility codes, these cards can have access to certain doors. Using this feature, the entry system can be set up for "zones".

Proximity Card: A credit size card that identifies itself when within close proximity of a reader. Card "swiping" is not necessary. The card contains a 3 digit Facility Code, a 5 digit Internal Card number and a 5 digit External Printed number, that may or may not match the Internal number.

B. Wiring

One local Wiegand device (typically a Proximity card reader) is fully supported (power and data) from the **AES-NET** interface. Connect only the black, red, green and white wires as shown below. Keep unused leads insulated.

In addition the **AES-NET** interface allows the **AES-2000** to communicate with the Viking model **ES-3** entry system door controller via a two wire CAN Communication Bus. CAN bus distances of up to 1/2 a mile (over 2600 feet) are achieved using common 24 gauge CAT-2 through CAT-5 wire, and 1 mile (5280 feet) is possible by doubling up on the 24 gauge twisted pair (or running at least 21 gauge). Up to 32 **ES-3** entry system door controllers may share the same CAN communication pair. The CAN bus must be polarity correct, so that all CAN-H connections and all CAN-L connections are common.

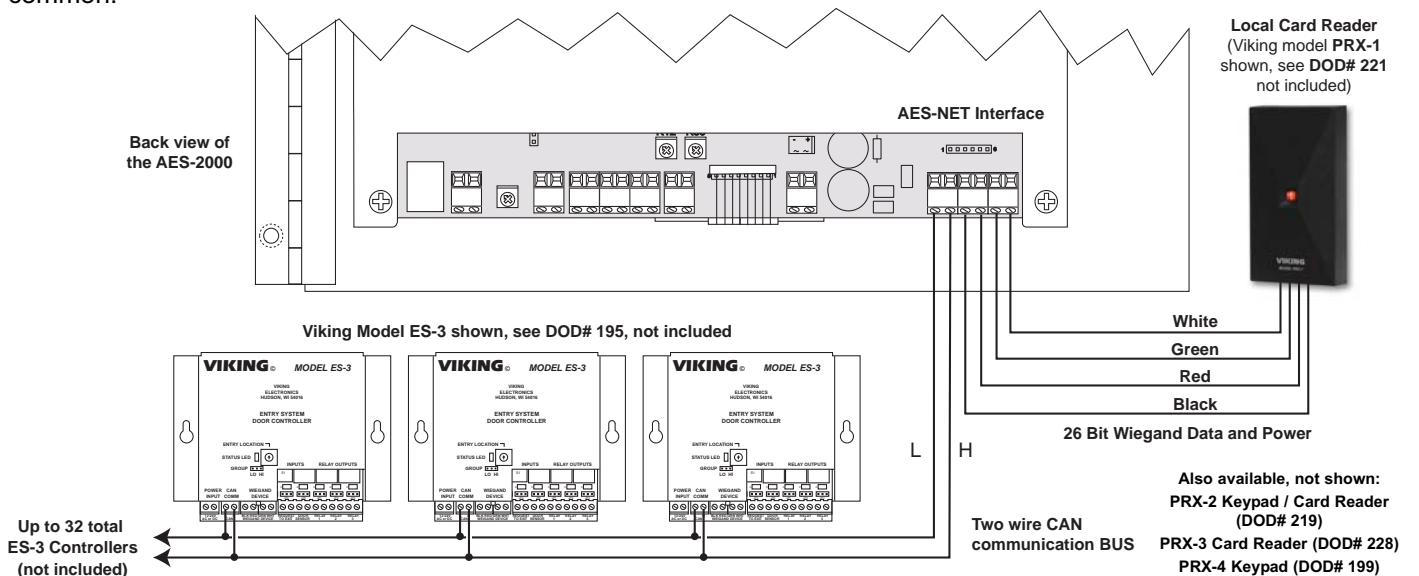

C. Programming

One local Wiegand type Card Reader can be added to the **AES-NET**. All valid card numbers must be programmed in the system for proper operation. This programming is done through the telephone line interface of the **AES-2000** using the **PB-100** with special software. This allows either remote programming from a distant location, or local programming using the Viking **DLE-300** line simulator. The **PB-100** is connected to a serial port of a P.C. and Windows based software is used to enter Facility codes, relay activation times and alarm conditions for each **ES-3** and the valid card numbers (as keyless entry codes) in the **AES-2000** data base.

Access the Remote Programmer software as described in the **AES-2000** Technical Practice. Proceed through the "Building Selection", "Apartment Selection and the "Security Code" screens until the "Data Transmit" screen appears. Then click the "Tools" pull down and select "Local Card Reader". The "Local Card Reader" screen will appear as shown right.

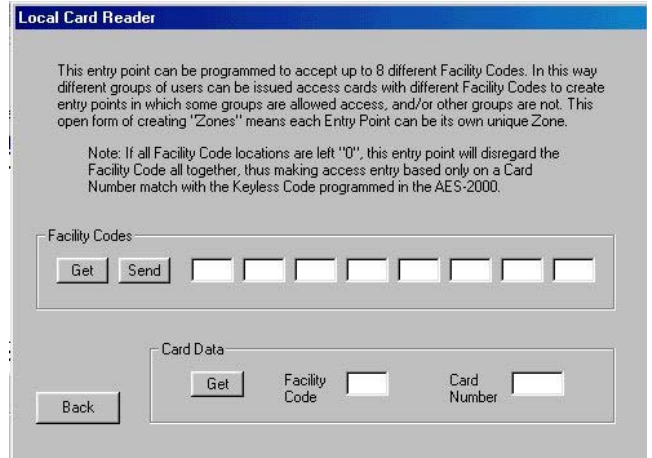

Twenty six bit Wiegand Access Cards, such as the Viking **PRX-C**, **PRX-C-ISO**, **PRX-FOB** and certain legacy HID® proximity protocols*, identify themselves with an eight digit number. The first three digits are considered the Facility Code and are programmed in this screen. The last five digits are the Internal Card Number, and are programmed as the **AES-2000** "Keyless Entry Code" for the person the card will be issued to. For example: If the facility code is **477** and the Internal Card number is **00023**, then program **477** as one of the Facility Codes to be used. The Internal Card number "**00023**" must be programmed into the **AES-2000** as the Keyless Entry Code for the given apartment (see the **Programming** section in the **AES-2000** Technical Practice). Up to eight different Facility Codes can be programmed.

* HID and the HID logo are registered trademarks of HID Global Corporation, an ASSA ABLOY company. All other trademarks are the property of their respective owners.

D. Operation

The **AES-NET** interface allows **ES-3** Entry System Access Controllers to communicate with the **AES-2000**'s main board to provide up to 32 remote access controlled entry points. The **AES-NET** interface also monitors a local Wiegand device (ie, proximity card reader) for 26 bit data. When data is received, it is sent to the **AES-2000** which compares it against the programmed data base. If the Facility Code matches, and the card number matches a programmed Keyless Entry Code, access will be granted just as if the tenant dialed the keyless entry code on the **AES-2000** keypad.

Operation

A. General

The **AES-2000** is designed to use the public switched phone network as a link between the door or gate entry of an apartment building and the individual tenant's apartment. The system enables the tenant to speak to the visitor before allowing them to enter the building. To gain access to a building, the visitor must enter a code pertaining to the apartment they wish to visit, and then speak to a person in the apartment

Back-Lit LCD Alpha Numeric Display

EZ™ Help Operating Instructions

Panel Lock

Metal Keypad

Panel: Brushed 12 Gauge Stainless Steel 12" x 9.5"

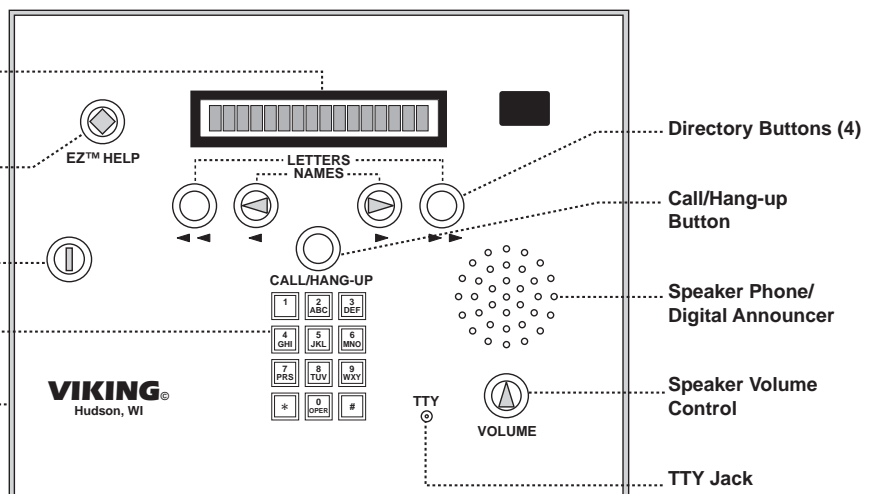

using the built in hands-free phone. The apartment tenant could then dial a single digit "opener code" on their Touch Tone phone to operate a door strike to allow entry. If the apartment access code is known, it may be entered by using the telephone keypad. If the apartment access code is not known, the apartment directory can be used. The directory is displayed with 1/2" tall characters on the back-lit display. Alternatively, the tenant names can be broadcast over the speaker. When the correct tenant name is displayed/announced, the user simply presses the "Call" button and the **AES-2000** speed dials the tenants apartment. You may also call a tenant by entering the person's phone number on the keypad.

Warning: If the phone number entered matches one of the pre-programmed access codes, that number will be dialed.

Note: To avoid busy signals on the entry phone, call waiting is recommended on each tenant's phone line.

B. EZ™ Help Instructions

General operating instructions can be received by pressing the **EZ™ Help** button. The Help Message is displayed on the character display and also broadcast over the speaker. When the **EZ™ Help** button is pressed followed by another button, a voice message and display will give the function of that button. For one handed operation of the EZ™ Help messages, press the **EZ™ Help** button once, then press any other button on the panel for help on it's operation. A second press of the same button will cancel the help mode and normal operation of the button will proceed. The help voice will stay active through the entire length of the call.

C. Calling a Tenant

If the right arrow button is momentarily pressed, a name will be shown on the display and broadcast over the speaker*. If the right arrow button is pressed again, the next name in the directory will be displayed and announced*. In this manner, the entire tenant directory, name by name, can be reviewed. If the button is held, the voice directory* and display go into a high speed scan mode. The directory is always in alphabetical order, so the user can quickly get an idea as to where they are in the directory. When the button is released, the full name at that point in the directory will be announced* and displayed. If the desired name is passed, the user can press the left arrow button to reverse the direction and go back to the desired name. If a person stops for a few seconds on a name, the message **"Press Call to Dial"** is announced* and displayed. The two "Letters" buttons can be used to walk through the alphabet in the same manner. When the correct letter is reached, pressing the arrow button will display and announce* the first name at that alphabet letter.

When the desired name is displayed and announced*, the visitor can press the "Call" button and the phone number for that tenant will be dialed. When the dialing process starts, the audio from the phone line will be sent to the speaker and call progress information will be sent to the display. When the tenant answers their phone, **"Entry System"** will be announced and the visitor can talk to the tenant. When the tenant confirms the visitor's identity, a single digit "opener code" may be entered from the tenant's phone, a message will be displayed **"Door Unlocked"**, an audio "buzz" is heard and the door strike will be activated. After a few seconds the **AES-2000** will hang up automatically.

* **Note:** *Announcements are only broadcast over the loud speaker if the **EZ™ Help** button has been activated.*

D. Other Controls

Each time the volume button is pressed, the volume of the speaker is increased. If maximum level is reached, the next press will roll the volume level over to it's lowest level. The volume is reset to it's original starting point when the call is finished.

E. Keyless Entry

A tenant may use their personal keyless entry code to let themselves in by entering a **"#"** followed by their (1-6 digit) personal keyless entry code on the **AES-2000's** keypad. **Note:** *For more accurate entry logging (statistics) a minimum of a 3 digit keyless entry code is recommended.*

F. TTY

A TTY jack is available for TTY (teletypewriter) communication between tenants and the door. **Important:** *If TTY communication is needed, the "silence time out" must be disabled.*

G. Using the AES-2000 with the Viking C-3000

When using the **AES-2000** with the Viking **C-3000**, be sure to disable the **C-3000** "Relay Activation Code". For complete **C-3000** programming instructions, see the **C-3000** Technical Practice (**DOD# 162**). If more than 96 tenants need to be connected to **C-3000's**, see Application Note **DOD# 868**.

Product Support Line: 715.386.8666

Fax Back Line: 715.386.4345

Due to the dynamic nature of the product design, the information contained in this document is subject to change without notice. Viking Electronics, and its affiliates and/or subsidiaries assume no responsibility for errors and omissions contained in this information. Revisions of this document or new editions of it may be issued to incorporate such changes.