

# VIKING PRODUCT MANUAL

COMMUNICATION & SECURITY SOLUTIONS

## Viking Area of Refuge Signs Designed to Comply with IBC, ADA, NFPA and ICC Requirements



**ARS-TB100**

Tactile Blue Braille and raised letter sign to be placed next to the Area Of Refuge (stairwell exit) door.



**ARS-IB100**

Instructional Blue Braille and Raised letter sign to be placed next to the Area of Refuge emergency phone (E-1600A, etc.)



**ARS-LR100**

Lighted double sided Wall or ceiling mount sign to be placed above the Area Of Refuge (stairwell exit) door.



**ARS-DLB100**



**ARS-DRB100**

Directional Blue signs with left or right arrow to be placed next to exit doors without Area Of Refuge.

The **ARS Series** Area of Refuge Signs are designed to comply with IBC 1007,1011, ADA 4.3.11, NFPA 22, 101 and ICC 703 code requirements. The **ARS-LR100** is an LED illuminated edge-lit double sided hanging Sign. It is AC powered with 3 hour battery backup. The unit can be ceiling mounted, mounted flat against a wall or end mounted so it can be viewed from either direction. The Instructional, Tactile and Directional signs are made from Acrylic or durable ABS plastic and are designed to adhere to the wall with the provided double sided foam tape.

### Features

- **ARS-LR100:** Red LED edge lit wall sign, 120/277V AC power, Included NiCad battery delivers over 3 hours of battery backup, UL listed, Universal wall, side or ceiling mounting, Silver aluminum housing with mirrored double sided acrylic sign surface, Battery test button, AC pwr LED, Low voltage automatic battery disconnect to prevent deep cycling battery, mounting hardware and 4 optional Chevron arrows with mounting templates included.
- **ARS-TB100:** 6" wide x 9" tall Tactile Sign with 0.031" raised white letters and accessibility symbol, California compliant Contracted Grade 2 Braille. Blue PMS 300 Acrylic with non-glare finish, 0.032" thick double sided foam included.
- **ARS-IB100:** 6" wide x 7.5" tall Instructional sign with 0.031" raised white "Push For Help" letters and engraved white text, California compliant Contracted Grade 2 Braille. Blue PMS 294 ABS with non-glare finish, 0.032" thick double sided foam included.
- **ARS-DLB100** (left arrow) and **ARS-DRB100** (right arrow): 12" wide x 4" tall Directional sign with engraved white text, Blue PMS 294 ABS with non-glare finish, 0.032" thick double sided foam included.
- **VE-ARSW:** Area of Refuge surface mount command center cabinet. Lockable for mounting "Two-Way Communications System" phone in low rise (less than 60 ft tall) buildings. See **DOD# 237**.

### Applications

- **ARS-LR100:** Placed above Area Of Refuge (stairwell exit) door
- **ARS-TB100:** Placed next to Area Of Refuge (stairwell exit) door
- **ARS-IB100:** Placed next to Area Of Refuge emergency phone (E-1600A, etc.)
- **ARS-DLB100** and **ARS-DRB100:** Placed next to exit doors without Area Of Refuge
- **VE-ARSW:** Cabinet placed in elevator lobby for mounting command center phone (see **DOD # 237**)

### Specifications

#### ARS-LR100

**Power:** 120/277V AC power 3 watts at 120V, 3 hour battery backup, UL 924 compliant  
**Weight:** 4.5 lbs.  
**Connections:** (3) wire nuts  
**Included Hardware:** Wall/ceiling mounting cover, universal electrical box mounting bracket, (2) M4 x 40 Phillips head screws, (2) #10-24 x 0.625" Phillips head screws, (2) #10-24 knupnuts, (4) adhesive backed Chevron arrows

#### ARS-TB100

**Material:** Acrylic PMS 300 blue with matte finish  
**Dimensions:** 6" x 9" x 0.093"  
**Weight:** 1.6 oz

#### ARS-IB100

**Material:** ABS and Acrylic PMS 294 blue with matte finish  
**Dimensions:** 6" x 7.5" x 0.093"  
**Weight:** 1.6 oz

#### ARS-DLB100 and ARS-DRB100

**Material:** ABS PMS 294 blue with matte finish  
**Dimensions:** 4" x 12" x 0.062"  
**Weight:** 3.2 oz

**VE-ARSW:** See **DOD# 237**

[www.vikingelectronics.com](http://www.vikingelectronics.com)  
**Information: (715) 386-8861**

# Installation and Specifications

## A. ARS-LR100 Lighted Double Sided Wall or Ceiling Mount Sign

### 1. Ceiling Mounting

<b>Step 1</b>	Plug the remaining holes with appropriate color plug.
<b>Step 2</b>	Attach crossbar to junction box, using junction box screws if needed (not included).
<b>Step 3</b>	Remove side plate and open aluminum housing cover, see Figure 1.
<b>Step 4</b>	Assemble canopy with aluminum housing, see Figure 3. Using holes "1" and "4" assemble canopy with (2) 10-24 screws and nuts.
<b>Step 5</b>	Adhere chevron(s) as required to the panel, then remove the chevron alignment templates. Note: Once chevrons have been attached to the panel, they can be removed but cannot be reused.
<b>Step 6</b>	Feed the leads from the circuit board through the center hole. You may use a holding wire, see Figure 4.
<b>Step 7</b>	Make the proper supply lead connections, see Figure 5. If using 120VAC, connect the black and white leads to the building utility. If using 277VAC, connect the orange and white leads to the building utility. Cap off unused wires. Use standard wire nuts when connecting to leads.
<b>Step 8</b>	Using M4 x 40 screws supplied, tighten canopy to mounting plate.
<b>Step 9</b>	Connect charge battery wire to circuit board.
<b>Step 10</b>	Assemble side plates and close aluminum housing cover, see Figure 2.

### 2. Side Mounting

<b>Step 1</b>	Plug the remaining holes with appropriate color plug.
<b>Step 2</b>	Attach crossbar to junction box, using junction box screws if needed (not included).
<b>Step 3</b>	Remove side plate and open aluminum housing cover, see Figure 1.
<b>Step 4</b>	Assemble canopy with aluminum housing, see Figure 6. Using holes "3" and "5" assemble canopy with (2) 10-24 screws and nuts.
<b>Step 5</b>	Adhere chevron(s) as required to the panel, then remove the chevron alignment templates. Note: Once chevrons have been attached to the panel, they can be removed but cannot be reused.
<b>Step 6</b>	Feed the leads from the circuit board through the center hole. You may use a holding wire, see Figure 4.
<b>Step 7</b>	Make the proper supply lead connections, see Figure 5. If using 120VAC, connect the black and white leads to the building utility. If using 277VAC, connect the orange and white leads to the building utility. Cap off unused wires. Use standard wire nuts when connecting to leads.
<b>Step 8</b>	Using M4 x 40 screws supplied, tighten canopy to mounting plate.
<b>Step 9</b>	Connect charge battery wire to circuit board.
<b>Step 10</b>	Assemble side plates and close aluminum housing cover, see Figure 2.

### 3. Back Mounting

<b>Step 1</b>	Plug the remaining holes with appropriate color plug.
<b>Step 2</b>	Attach crossbar to junction box, using junction box screws if needed (not included).
<b>Step 3</b>	Remove side plate and open aluminum housing cover, see Figure 1.
<b>Step 4</b>	Assemble canopy with aluminum housing, see Figure 3. Using holes "1" and "4" assemble canopy with (2) 10-24 screws and nuts.
<b>Step 5</b>	Adhere chevron(s) as required to the panel, then remove the chevron alignment templates. Note: Once chevrons have been attached to the panel, they can be removed but cannot be reused.
<b>Step 6</b>	Feed the leads from the circuit board through the center hole. You may use a holding wire, see Figure 4.
<b>Step 7</b>	Make the proper supply lead connections, see Figure 5. If using 120VAC, connect the black and white leads to the building utility. If using 277VAC, connect the orange and white leads to the building utility. Cap off unused wires. Use standard wire nuts when connecting to leads.
<b>Step 8</b>	Using M4 x 40 screws supplied, tighten canopy to mounting plate.
<b>Step 9</b>	Assemble aluminum housing to canopy using provided screws, see Figure 7.
<b>Step 9</b>	Connect charge battery wire to circuit board.
<b>Step 10</b>	Assemble side plates and close aluminum housing cover, see Figure 2.



Using fingers, squeeze the bottom of the cover and lift it

Fig. 1 Opening Aluminum housing cover

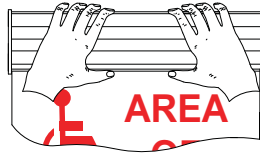

Squeeze little bit and push down

Fig. 2 Close Aluminum housing cover

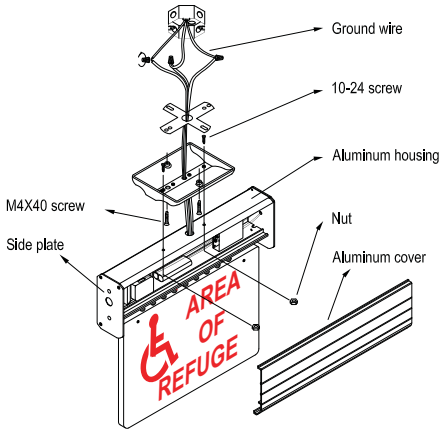

Fig. 3 Ceiling Mounting

**CAUTION:**  
Holding wire supports sign during wiring

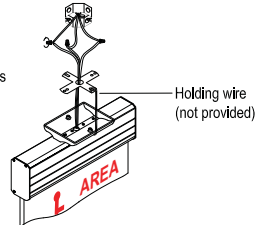

Fig. 4 Using holding wire

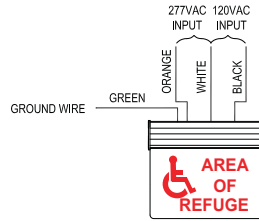

Fig. 5 Wiring diagram

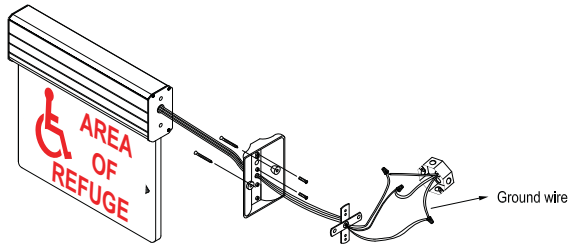

Fig. 6 Side Mounting

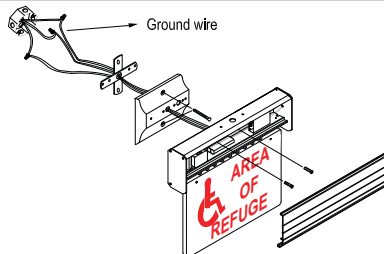

Fig. 7 Back (Wall) Mounting

## B. ARS-TB-100 Blue Tactile Braille Sign

- 1. Literary braille type:** Raster™ Contracted Grade 2 with .059 dot base diameter, .10 inter dot spacing, inter-cell spacing = .20, .025 dot height. (Rounded on top). California Title 24 compliant.
- 2. Material:** Single Ply Modified Acrylic
- 3. Adhesive:** 0.032" thick 3M 4462B double coated polyethylene foam with 745 rubber adhesive
- 4. Font:** Arial Bold
- 5. Background:** Blue PMS 300 matte non-glare finish
- 6. Text and Graphics:** PMS trans. white
- 7. Usage:** Interior signage and/or exterior signage
- 8. Thickness:** 1/16" (0.0625")
- 9. Edges:** Beveled
- 10. Durability:** UV stable, handles temperatures up to 175°F



### ARS-TB100 Mounting Height and Location to Comply with ICC (International Code Council) 2009

**703.3.10 Height above Floor.** Raised characters shall be 48 inches (1220mm) minimum above the floor, measured to the baseline of the lowest raised character and 60 inches (1525mm) maximum above the floor, measured to the baseline of the highest raised character.

**703.3.11 Location.** Where a sign containing raised characters and braille is provided at a door, the sign shall be alongside the door at the latch side. Where a sign containing raised characters and braille is provided at double doors with one active leaf, the sign shall be located on the inactive leaf. Where a sign containing raised characters and braille is provided at double doors with two active leaves, the sign shall be to the right of the right-hand door. Where there is no wall space on the latch side of a single door, or to the right side of double doors, signs shall be on the nearest adjacent wall. Signs containing raised characters and braille shall be located so that a clear floor area 18 inches (455mm) minimum by 18 inches (455mm) minimum, centered on the raised characters is provided beyond the arc of any door swing between the closed position and 45 degrees open position.

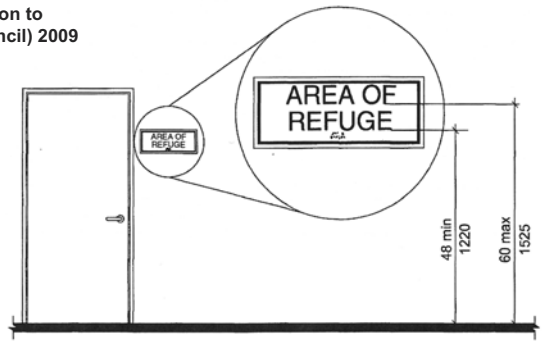

Note: For braille character mounting height see Section 703.4.5

**FIG. 703.3.10  
HEIGHT OF RAISED CHARACTERS ABOVE FLOOR**

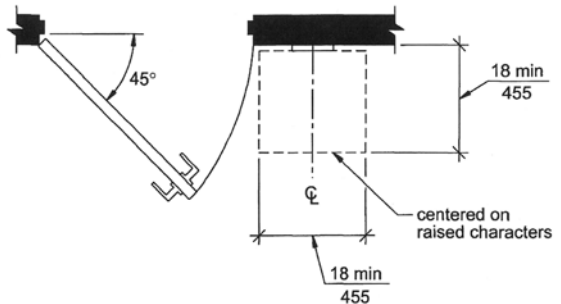

**FIG. 703.3.11  
LOCATION OF SIGNS AT DOORS**

### C. ARS-IB-100 Blue Instructional Braille Sign

- Literary braille type:** Raster™ Contracted Grade 2 with .059 dot base diameter, .10 inter dot spacing, inter-cell spacing = .20, .025 dot height. (Rounded on top). California Title 24 compliant.
- Material:** 2-Ply Micro Surfaced ABS and 1-Ply modified Acrylic.
- Adhesive:** 0.032" thick 3M 4462B double coated polyethylene foam with 745 rubber adhesive
- Font:** Arial Bold
- Background:** Pantone blue 294, matte finish
- Text and Graphics:** PMS trans. white
- Durability:** UV stable, handles temperatures up to 175°F

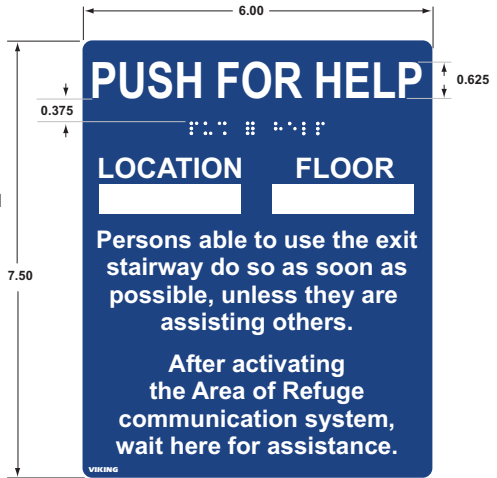

### D. ARS-DLB100 Blue Left Arrow Directional Sign



- Material:** 2-ply microsurfaced ABS
- Adhesive:** 0.032" thick 3M 4462B double coated polyethylene foam with 745 rubber adhesive.
- Font:** Arial Bold
- Background:** Blue PMS 294 matte non-glare patterned finish
- Text and Graphics:** PMS trans. white
- Usage:** Interior signage
- Thickness:** 1/16" (.0625")
- Edges:** Straight
- Durability:** UV stable, handles temperatures up to 175°F

### E. ARS-DRB100 Blue Right Arrow Directional Sign



- Material:** 2-ply microsurfaced ABS
- Adhesive:** 0.032" thick 3M 4462B double coated polyethylene foam with 745 rubber adhesive.
- Font:** Arial Bold
- Background:** Blue PMS 294 matte non-glare patterned finish
- Text and Graphics:** PMS trans. white
- Usage:** Interior signage
- Thickness:** 1/16" (.0625")
- Edges:** Straight
- Durability:** UV stable, handles temperatures up to 175°F

## Requirements for INSIDE the Area of Refuge

### Two-Way Communications



Model 1600A Series

### Instructional Signage



Model ARS-IB100

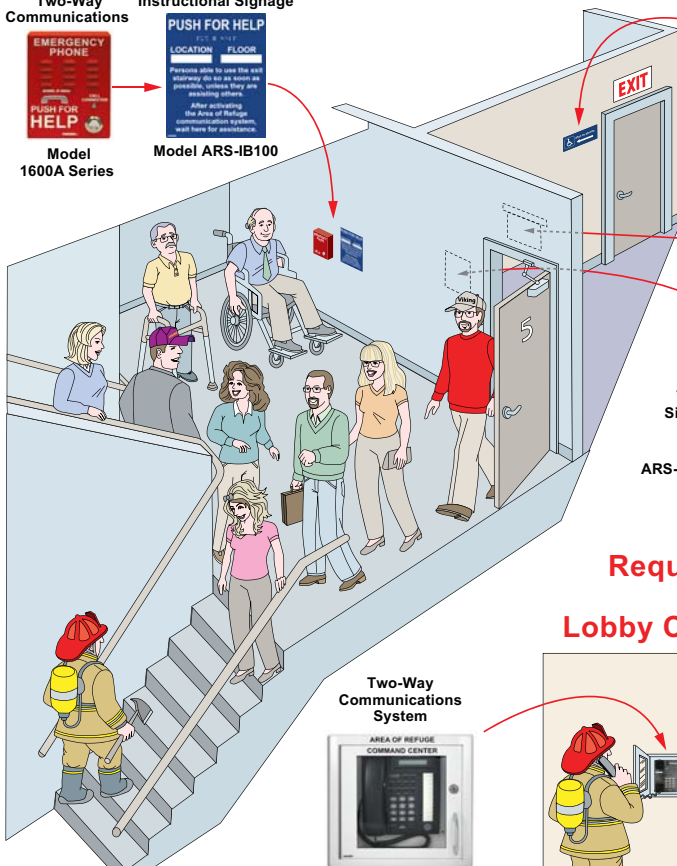

**As required by the following codes:**  
**IBC 1007, 1011**  
**ICC 703**  
**NFPA 22, 101**  
**ADA 4.3.11**

## Requirements for OUTSIDE the Area of Refuge

### Directional Signage



Model ARS-DLB100 (Left arrow)  
 Model ARS-DRB100 (Right arrow)

### Illuminated Signage



Model ARS-LR100

### Tactile Signage



Model ARS-TB100

## Requirements for the Area of Refuge Lobby Command Center

### Two-Way Communications System



**Area of Refuge Command Center**  
 (phone in locked cabinet located in the elevator lobby\*)

**Refuge Locking Command Center Enclosure**  
 Model VE-ARSW (surface mount)

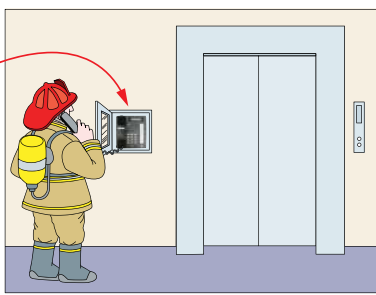

\* For buildings under 60 ft. For taller buildings, the Refuge Command Center phone should be located in the Fire Command Center.

## Recommendations for 6 or Less Area of Refuge Emergency Phones

High Efficiency UPS (Tripp-Lite model Internet55U or equivalent)

6 Port Line Concentrator Model LC-6

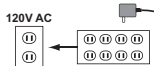

Connect up to 6 Area of Refuge emergency phones (1600A Series) to one command center phone and one C.O. line. UPS must have a minimum of 90 minute backup.

## Recommendations for 7-24 Area of Refuge Emergency Phones

High Efficiency UPS (Minuteman Entrust Series ETR700 or equivalent)

Panasonic KX-TA824



Using a Panasonic KX-TA824 with optional expansion cards KX-TA82483 and KX-TA82470, connect up to 24 Area of Refuge emergency phones (1600A Series) to one command center phone and one C.O. line. UPS must have a minimum of 90 minute backup. **Note:** The Panasonic KX-TA824 can be expanded (in increments of 6) up to 144 ports by adding a Viking LC-6 to each station port.

## A. Model VE-ARSW Area of Refuge Surface Mount Command Center Cabinet

Each Area of Refuge is required to have a central control point (Command Center) where the emergency phones call for assistance.

In low rise buildings (less than 60 ft. tall) the Command Center can simply be a telephone mounted in a cabinet located on the ground floor of the elevator lobby. The **VE-ARSW** cabinet is ideal for this application, allowing you to mount a single line phone or PABX Key phone.

The **VE-ARSW** is a 13" x 13.5" x 4" surface mount metal cabinet with a hinged door, roller catch, chrome handle, phone mounting studs and optional lock. The lock is equipped with a breakaway cam allowing emergency personnel to force the door open if the key cannot be found.



For more info see **DOD# 237**

### Features

- 20 gauge galvaneal steel cabinet with gloss white powder coat finish
- Optional roller catch to keep door closed when not using the lock
- Lock with breakaway cam and two keys
- Heavy duty chrome plated cast handle
- Mounting studs on back panel for mounting any standard wall phone
- Hinged door with clear acrylic window

### Specifications

**Material:** 20 gauge galvaneal steel

**Finish:** Gloss white powder paint

**Dimensions:** 13" x 13.5" x 4" (330.2mm x 342.9mm x 101.6mm)

**Weight:** 8.0 lbs (3.63 kg)

## B. Model LC-6 Concentrates up to Six Area of Refuge Emergency Phones



For more info see **DOD# 245**

The **LC-6** Line Concentrator eliminates the monthly charges for a dedicated line to each Area of Refuge. The **LC-6** is designed to be used with the Viking **1600A Series** Emergency Phones. Up to six of these emergency phones can communicate with authorized personnel on 3 other phones within a building, or add a telephone line to allow communication outside the building. A call initiated by an emergency phone can dial internally, externally, or both. Any other phones that are activated will be bridged with authorized personnel.

All telephone line inbound calls are answered by the **LC-6**. A touch tone command will route the call to any of the phone ports. If no command is detected within 4

seconds, the call will be routed to the last emergency phone that was used. This allows emergency personnel to easily call back to the same phone.

Connections include a Fire Floor phone, a Machine Room phone and a Lobby phone. An output is also provided for driving up to two Viking **LM-24D** displays to show status of all ports.



## C. Your Emergency Device Can Share a Line with You Phone System



Why pay for a dedicated line for your elevator/emergency phone or alarm panel?

The **LSR-1** Line Seizure Relay allows the user to share an existing phone line with an emergency phone or other priority alarm device. This can save hundreds of dollars a year over leasing a dedicated phone line.

The **LSR-1** can be used on any C.O. line or analog PABX/KSU station.

**Important:** When the emergency device is in use, the phone line is not available for normal use. Any additional emergency calls will have to be made on another phone line. For this reason the **LSR-1** is not recommended for single line applications.

**Note:** Connecting more than one set of microphone and speaker combinations to the **LSR-1** may infringe on US Patent 5,386,463.

For more info see DOD# 230

## Warranty

IF YOU HAVE A PROBLEM WITH A VIKING PRODUCT, CONTACT: VIKING TECHNICAL SUPPORT AT (715) 386-8666

Our Technical Support Department is available for assistance Monday through Friday 8am - 5pm central time. So that we can give you better service, before you call please:

1. Know the model number, the serial number and what software version you have (see serial label).
2. Have your Product Manual in front of you.
3. It is best if you are on site.

### RETURNING PRODUCT FOR REPAIR

The following procedure is for equipment that needs repair:

1. Customer must contact Viking's Technical Support Department at 715-386-8666 to obtain a Return Authorization (RA) number. The customer MUST have a complete description of the problem, with all pertinent information regarding the defect, such as options set, conditions, symptoms, methods to duplicate problem, frequency of failure, etc.
2. Packing: Return equipment in original box or in proper packing so that damage will not occur while in transit. Static sensitive equipment such as a circuit board should be in an anti-static bag, sandwiched between foam and individually boxed. All equipment should be wrapped to avoid packing material lodging in or sticking to the equipment. Include ALL parts of the equipment. C.O.D. or freight collect shipments cannot be accepted. Ship cartons prepaid to: **Viking Electronics, 1531 Industrial Street, Hudson, WI 54016**
3. Return shipping address: Be sure to include your return shipping address inside the box. We cannot ship to a PO Box.
4. RA number on carton: In large printing, write the R.A. number on the outside of each carton being returned.

### RETURNING PRODUCT FOR EXCHANGE

The following procedure is for equipment that has failed out-of-box (within 10 days of purchase):

1. Customer must contact Viking's Technical Support at 715-386-8666 to determine possible causes for the problem. The customer MUST be able to step through recommended tests for diagnosis.
2. If the Technical Support Product Specialist determines that the equipment is defective based on the customer's input and troubleshooting, a Return Authorization (R.A.) number will be issued. This number is valid for fourteen (14) calendar days from the date of issue.
3. After obtaining the R.A. number, return the approved equipment to your distributor, referencing the R.A. number. Your distributor will then replace the Viking product using the same R.A. number.
4. **The distributor will NOT exchange this product without first obtaining the R.A. number from you. If you haven't followed the steps listed in 1, 2 and 3, be aware that you will have to pay a restocking charge.**

### TWO YEAR LIMITED WARRANTY

Viking warrants its products to be free from defects in the workmanship or materials, under normal use and service, for a period of two years from the date of purchase from any authorized Viking distributor. If at any time during the warranty period, the product is deemed defective or malfunctions, return the product to Viking Electronics, Inc., 1531 Industrial Street, Hudson, WI., 54016. Customer must contact Viking's Technical Support Department at 715-386-8666 to obtain a Return Authorization (R.A.) number.

This warranty does not cover any damage to the product due to lightning, over voltage, under voltage, accident, misuse, abuse, negligence or any damage caused by use of the product by the purchaser or others. This warranty does not cover non-EWP products that have been exposed to wet or corrosive environments. This warranty does not cover stainless steel surfaces that have not been properly maintained.

**NO OTHER WARRANTIES.** VIKING MAKES NO WARRANTIES RELATING TO ITS PRODUCTS OTHER THAN AS DESCRIBED ABOVE AND DISCLAIMS ANY EXPRESS OR IMPLIED WARRANTIES OR MERCHANTABILITY OR FITNESS FOR ANY PARTICULAR PURPOSE.

**EXCLUSION OF CONSEQUENTIAL DAMAGES.** VIKING SHALL NOT, UNDER ANY CIRCUMSTANCES, BE LIABLE TO PURCHASER, OR ANY OTHER PARTY, FOR CONSEQUENTIAL, INCIDENTAL, SPECIAL OR EXEMPLARY DAMAGES ARISING OUT OF OR RELATED TO THE SALE OR USE OF THE PRODUCT SOLD HEREUNDER.

**EXCLUSIVE REMEDY AND LIMITATION OF LIABILITY.** WHETHER IN AN ACTION BASED ON CONTRACT, TORT (INCLUDING NEGLIGENCE OR STRICT LIABILITY) OR ANY OTHER LEGAL THEORY, ANY LIABILITY OF VIKING SHALL BE LIMITED TO REPAIR OR REPLACEMENT OF THE PRODUCT, OR AT VIKING'S OPTION, REFUND OF THE PURCHASE PRICE AS THE EXCLUSIVE REMEDY AND ANY LIABILITY OF VIKING SHALL BE SO LIMITED.

IT IS EXPRESSLY UNDERSTOOD AND AGREED THAT EACH AND EVERY PROVISION OF THIS AGREEMENT WHICH PROVIDES FOR DISCLAIMER OF WARRANTIES, EXCLUSION OF CONSEQUENTIAL DAMAGES, AND EXCLUSIVE REMEDY AND LIMITATION OF LIABILITY, ARE SEVERABLE FROM ANY OTHER PROVISION AND EACH PROVISION IS A SEPARABLE AND INDEPENDENT ELEMENT OF RISK ALLOCATION AND IS INTENDED TO BE ENFORCED AS SUCH.

**Product Support: (715) 386-8666**

Due to the dynamic nature of the product design, the information contained in this document is subject to change without notice. Viking Electronics, and its affiliates and/or subsidiaries assume no responsibility for errors and omissions contained in this information. Revisions of this document or new editions of it may be issued to incorporate such changes.