

VIKING PRODUCT MANUAL

SECURITY & COMMUNICATION SOLUTIONS

Add One or Two Doorboxes to an Existing Phone Line and Provide CCTV Camera Control

The **C-1000B** allows single line phones or phone systems to share a phone line with one or two Viking doorboxes or paging amplifiers. The **C-1000B** provides two Touch Tone controlled relays to operate door strikes or gate openers and **provides doorbox triggered CCTV camera switching**.

The **C-1000B** allows Viking doorboxes and paging amplifiers to be used on single line, residential or home office applications as well as on fully loaded systems, because they are no longer limited to installation on unused trunk ports.



Features

- Allows two **Viking** doorboxes or **Viking** paging amplifiers to share a single telephone line with a residential or business telephone system
- **Programmable door strike activation code**
- Doorbox triggered CCTV camera switching
- Custom ringing mode allows you to distinguish doorbox calls from C.O. calls
- Compatible with up to two of the following **Viking** doorbox models: **W-1000**, **W-2000A**, or **W-3000**. Alternatively, the Analog PABX/KSU station mode allows compatibility with a single **Viking** handsfree phone (**E-10A**, **E-20B**, **E-30**, **K-1700-3** or **1600A Series**, etc.)
- Compatible with **Viking's** Single Line Paging Controller, Model **SLP-1**
- Call waiting tones indicate which doorbox is calling and distinguish a doorbox call from a C.O. line call
- Calls can be placed on hold when visitors call from the doorbox or when paging
- Provides two Touch Tone controlled N.O. or N.C. dry contact closures (5 amp rating) for door strikes or gate openers
- Keyless entry/postal lock input
- Built-in talk battery for "No C.O. Line" applications
- Auxiliary contact output for doorbells, lights, etc.

Applications

- Add one or two **Viking** doorboxes to your home or office phones
- **Switch between two CCTV cameras automatically when either doorbox is activated**
- Add a **Viking SLP-1** or **SLP-4** Single Line Paging Controller to provide paging, intercom, loud ringing, door chime and music on hold features
- Provide commercial or residential security via two-way handsfree communication from a door or gate
- Use as a line concentrator (one fax machine or answering machine can answer three lines)

www.VikingElectronics.com
Information: 715-386-8861

Specifications

Power: 120V AC/13.8V AC 1.25A, UL listed adapter provided
Dimensions: 5.25" x 4.1" x 1.75" (133mm x 104mm x 44mm)
Shipping Weight: 2 lb (0.9 kg)
Environmental: 32° F to 90° F (0° C to 32° C) with 5% to 95% non-condensing humidity
Door Strike Relay Contacts: 5A @ 30V DC/250V AC maximum
CCTV/Auxiliary Relay Contacts: .5A @ 125V AC, 1A @ 30V DC
Pulse Dialing Detection: 10 pps
Talk Battery: 28V DC
Maximum Doorbox Power Supply Length: 100 ft, 24 AWG wire
Connections: (1) 7 position terminal block and (1) 19 position terminal block

Features Overview

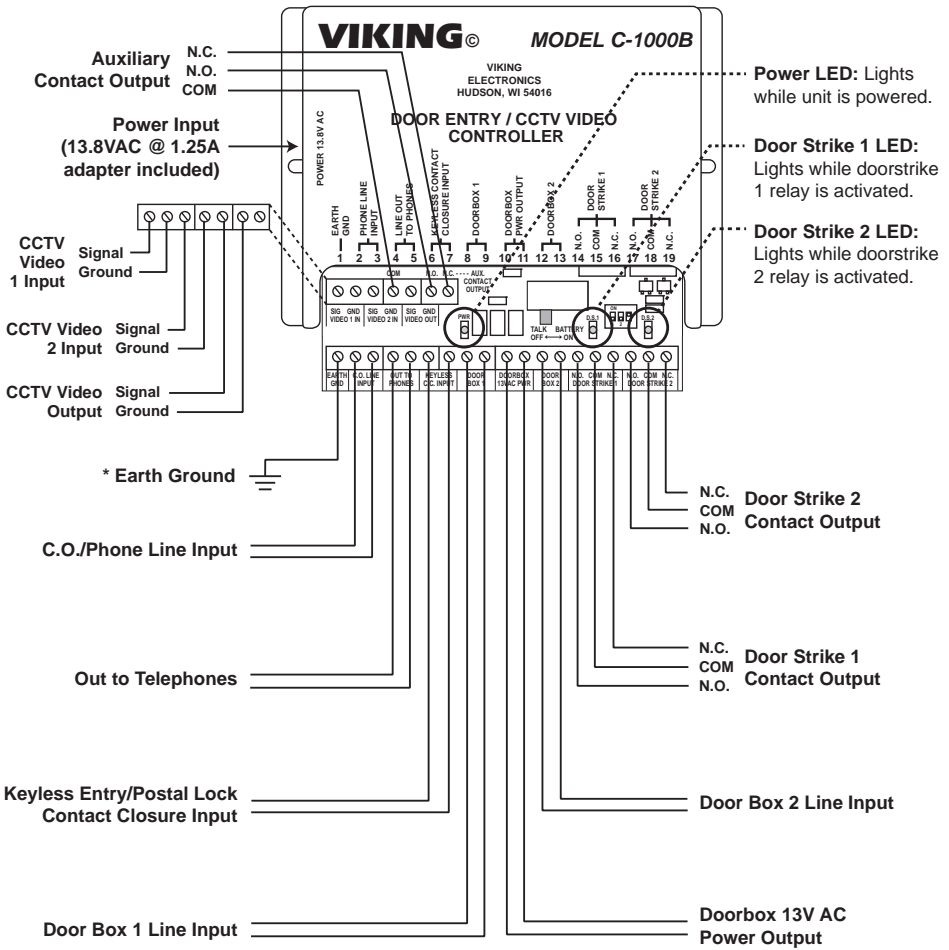

Installation

IMPORTANT: Electronic devices are susceptible to lightning and power station electrical surges from both the AC outlet and the telephone line. It is recommended that a surge protector be installed to protect against such surges.

A. One or Two Doorboxes Sharing a Phone Line and Controlling Two Optional Cameras

See **Operation**, section A.

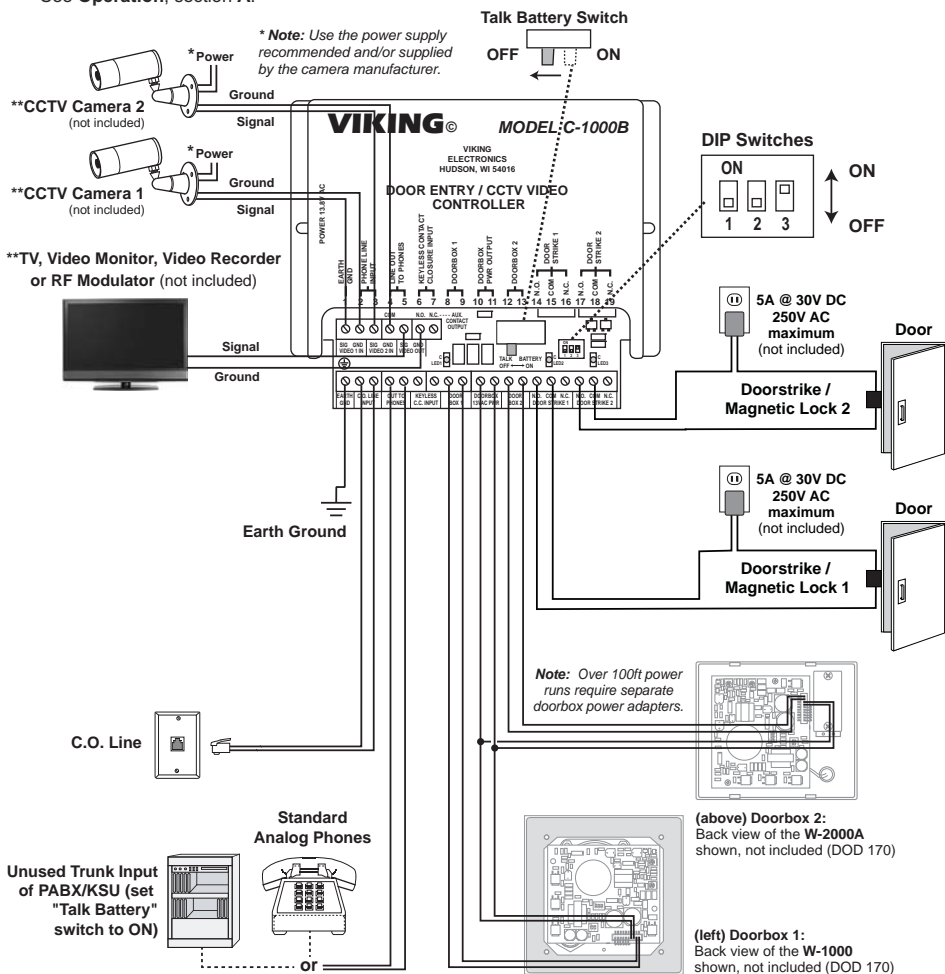

**** Note:** The C-1000B must be programmed with (*8) to control cameras. In the CCTV video control mode (*8), Auxiliary Contact Mode is disabled.

B. Provide Paging, Doorbox, and Doorstrike Control with Unique Front and Back Door Chimes

Note: To provide unique front and back door chimes, the **C-1000B** must be programmed to enable the "Auxiliary Contact Mode" (*7) and have the auxiliary contact programmed for custom ring cadence (**12#03**). Doorbox ringing can also be disabled by placing the **C-1000B** in the "Doorbell Mode" (*1). See **Quick Programming Features**, page 6. The **C-1000B** CCTV Video Control Mode can **NOT** be used in conjunction with unique front and back door chimes. The caller's music on hold is limited to 5 seconds while the home owner is communicating with a doorbox. The **Inhibit Auxiliary Ring Cadence mode** (*9) can be used to inhibit the **C-1000B** from triggering the **SLP-1** during a phone call (since call waiting tones will be heard).

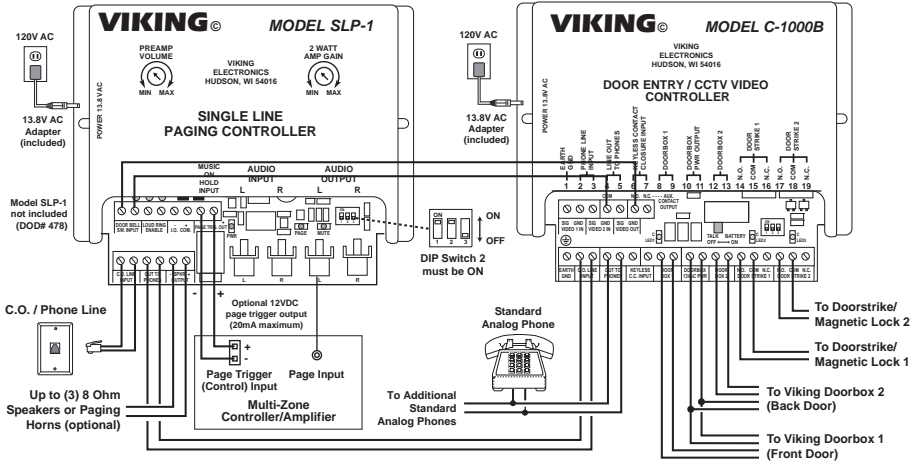

C. Using a C-1000B without a C.O. Line

The **C-1000B** can also be used without a C.O. line. This is ideal for connecting the **C-1000B** to an unused trunk/line input of your phone system or connecting to phones used only for doorbox communication.

Step 1.	Connect the power, required doorboxes, and doorstrike outputs (if required) as shown in section A.
Step 2.	Connect an analog phone or unused PABX/KSU trunk port to terminals 4 & 5, "LINE OUT TO PHONES" on the C-1000B .
Step 3.	Be sure the "Talk Battery Switch" is in the ON position.

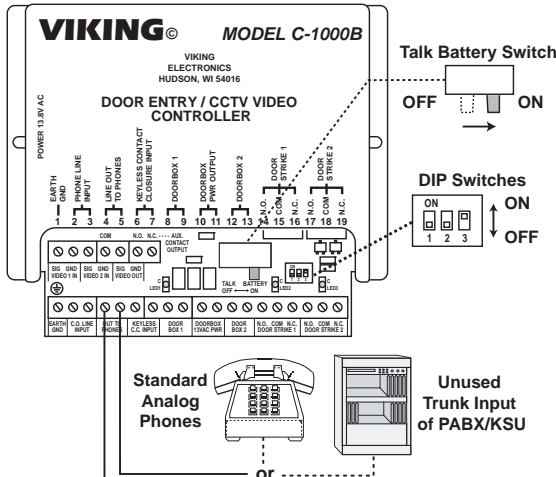

D. Using the C-1000B with Keyless Entry, Proximity Card Reader or a Postal Lock Switch

Step 1.	Connect a device that can provide a momentary contact closure, such as the Viking ES-1 with PRX-1 Card Reader or PRX-4 Keypad, keyed switch, postal lock with limit switch, etc. to terminals 6 & 7, "KEYLESS CONTACT CLOSURE INPUT".
Step 2.	Connect doorboxes and doorstrike outputs (if required) as shown in section A.
Step 3.	See Operation section E. Keyless Entry/Postal Lock.

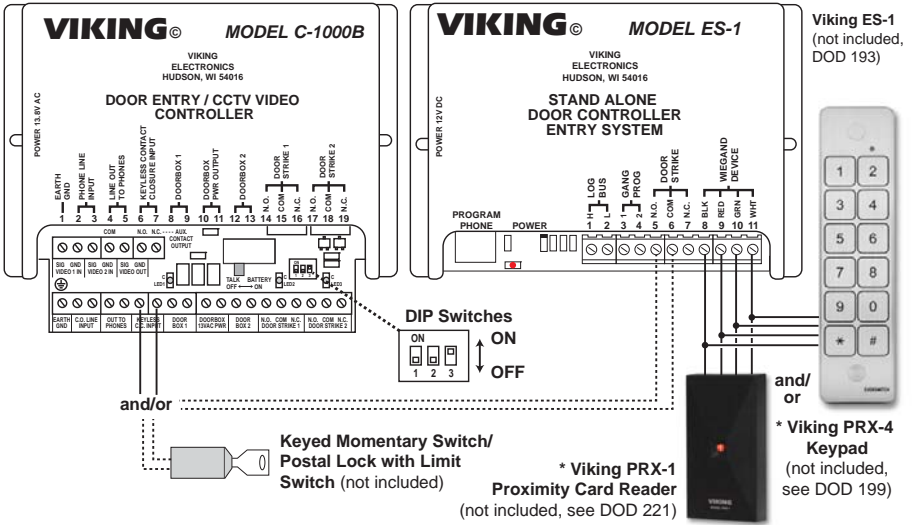

* Note: Also available, not shown: Viking PRX-2 Card Reader/Keypad (DOD 219) and Viking PRX-3 Card Reader (DOD 228), Viking PRX-4 Keypad (DOD 199) and Viking PRX-5 Card Reader/Keypad (DOD 224) and Viking LRR-4 Long Range Receiver (DOD 226).

E. Using the C-1000B to Trigger a Doorbell

Step 1.	Connect the doorbell (not included) as shown to the right. Note: The C-1000B will not supply power to the doorbell, a power adapter is necessary.
Step 2.	Connect doorboxes and doorstrike outputs (if required) as shown in section A.
Step 3.	Program the Auxiliary Contact Output as desired (see Programming section B).
Step 4.	See Operation section F. Auxiliary Contact Mode.

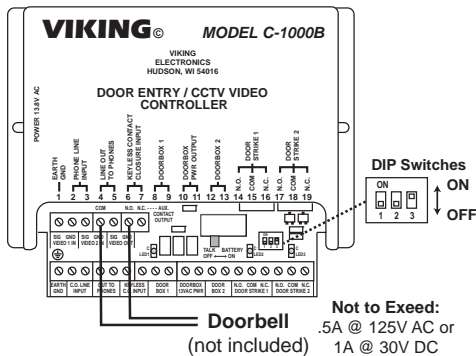

F. Line Concentrator Mode (One Telecom Device Can Answer up to Three Lines)

The **C-1000B** can be used as a line concentrator, allowing up to three separate C.O. lines to connect to one telecom device. For more information, see DOD 872.

G. Using the C-1000B with Three Doorbells and No C.O. Line

The **C-1000B** can be used to control up to three doorbells. For more information, see DOD 872.

H. Using the C-1000B on an Analog Station Port (Analog PABX/KSU Station Mode)

Note: This mode can NOT be used with **W-1000**, **W-2000A** or **W-3000** doorbells. This application is ideal for connecting the **C-1000B** to an unused analog station of your phone system. See **Programming** section F.

Important: 1. In this application, only a single door phone is used and *5 must be selected when programming.
2. Do not program the CCTV Video Control Mode (*8) in this application (See Note 2 below).
Only Auxiliary Contact Mode (*7) can be used.

Notes: *1. The **K-1700-3**'s keypad can be used for extension dialing, etc., but can NOT be used for keyless entry (see **Installation** section D).
2. If "Switched" camera control is needed (for a switching video RF modulator), connect the camera to "Video 2 In", connect the RF Modulator to "Video Out" and program the **C-1000B** with *7 and "11 # 03".
3. Once the "Analog PBX/KSU Station Mode" (*5) has been programmed, you are not able to access the programming mode of the **C-1000B** in the normal fashion. For details, see **Programming**, Section A.
4. The **K-1900-5's touch tone and flash restrictions must be disabled (*02). See the **K-1900-5 Product Manual** for complete programming instructions, **DOD 317**.

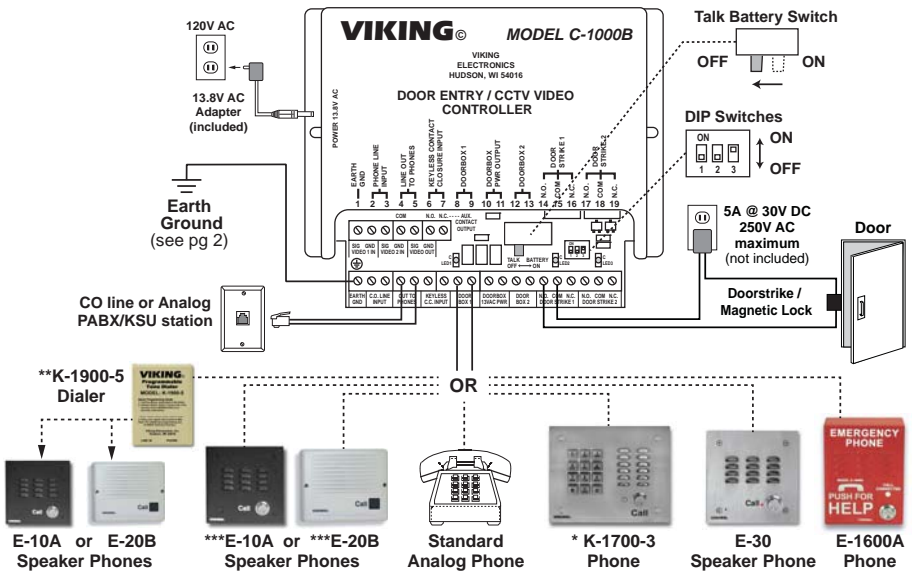

*** Note: The **E-10A** and **E-20B** Speaker Phones may be used without a dialer when installed on a ring-down circuit.

Need more information on the products shown above? Go to: www.vikingelectronics.com and enter the DOD:

Model	DOD	Description
E-10A / E-20B	210	Handsfree Speaker Phones
E-30	212	Vandal Resistant Handsfree Speaker Phone
E-1600A	215	Emergency/Elevator Phone
K-1700-3	157	Handsfree Speaker Phone with Keypad
K-1900-5	317	Touch Tone Dialer

Programming

Follow sections 1 or 2 to program a new **C-1000B** or any **C-1000B** that has not been previously programmed into the **Analog PBX/KSU Station Mode** (*5). If the **Analog PBX/KSU Station Mode** has been programmed, follow sections 3 or 4 to access programming. **Note:** *If you are not sure how the C-1000B was previously programmed and have difficulty accessing the programming mode by following sections 1 or 2, follow sections 3 or 4 in case the C-1000B is currently in the Analog PABX/KSU Station Mode (*5).*

A. Accessing the Programming Mode

1. Accessing the Programming Mode Locally (Security Code Bypass Mode)

Step 1.	Disconnect the PHONE LINE INPUT .
Step 2.	Slide the TALK BATTERY switch to the ON position.
Step 3.	Move DIP switch 2 from OFF to ON (see Programming section E).
Step 4.	Come off-hook with a phone connected to terminals 4 & 5, LINE OUT TO PHONES .
Step 5.	A double beep will indicate that you have accessed the programming mode.
Step 6.	You can now Touch Tone program the features listed in Programming section B.
Step 7.	When finished programming, hang up and move DIP switch 2 to the OFF position.
Step 8.	Slide the TALK BATTERY switch back to the OFF position.
Step 9.	Reconnect the phone line to the PHONE LINE INPUT .

2. Accessing the Programming Mode Remotely

Step 1.	Call into the C-1000B from a Touch Tone phone.
Step 2.	Answer the call using the phone (device) connected to terminals 4 & 5, LINE OUT TO PHONES .
Step 3.	From either phone enter * followed by the security code (factory set to 845464 , see Programming section D).
Step 4.	A double beep will indicate that you have accessed the programming mode.
Step 5.	You can now Touch Tone program the features listed in Programming section B.
Step 6.	When finished, hang up both phones to exit the programming mode.

Note: Programming from a cell-phone may not be suitable in areas with weak coverage.

IMPORTANT: Only use Sections 3 or 4 when the C-1000B has previously been programmed into the "Analog PBX/KSU Station Mode" (*5)

3. Accessing the Programming Mode Locally (When *5 mode has been programmed)

Step 1.	Connect a PBX/KSU analog extension (or phone line) to terminals 4 & 5, LINE OUT TO PHONES .
Step 2.	Slide the TALK BATTERY switch to the OFF position.
Step 3.	Move DIP switch 2 from OFF to ON (see Programming section E).
Step 4.	Come off-hook with a phone connected to terminals 8 & 9 DOORBOX 1 .
Step 5.	PBX/KSU dial tone will be heard along with a double beep from the C-1000B to indicate that you have accessed the programming mode.
Step 6.	You can now Touch Tone program the features listed in Programming section B (ignore busy signals, reorder tones or intercept messages heard while programming).
Step 7.	When finished programming, hang up and move DIP switch 2 to the OFF position.

4. Accessing the Programming Mode Remotely (When *5 mode has been programmed)

Note: *To access programming in this fashion, there must be a PBX/KSU analog extension (or phone line) connected to terminals **4 & 5, LINE OUT TO PHONES** and the **TALK BATTERY** switch must be set to **OFF**.*

Step 1.	From another extension or phone line, call into the PBX/KSU analog extension (or phone line) connected to terminals 4 & 5, LINE OUT TO PHONES .
Step 2.	Answer the call using the phone (or device) connected to terminals 8 & 9, DOORBOX 1 .
Step 3.	From the remote phone enter * followed by the six digit security code (factory set to 845464, see Programming section D).
Step 4.	A double beep will indicate that you have accessed the programming mode.
Step 5.	You can now Touch Tone program the features listed in Programming section B..
Step 6.	When finished programming, hang up both phones.

B. Quick Programming Features

Description	Enter Digits	+	Location
Door strike 1 activation time .5 - 10 seconds (00 = .5 seconds/factory default)	2 digits (00-10)	+	#01
Door strike 2 activation time .5 - 10 seconds (00 = .5 seconds/factory default)	2 digits (00-10)	+	#02
Door Strike Activation Code (factory set to **)	1 digits (0-9)	+	#40
	2 digits (0-9 , *)	+	#40
Security Code (factory set to 845464)	6 digits (0-9)	+	#47
Disable special modes (*1 - *6 and *8 - *9) listed below (factory default)	*0		
* Doorbell mode	*1		
* Custom ring mode	*2		
* Multiple relay activation mode	*3		
* Paging mode (not for use with SLP-1, see Programming section G)	*4		
* Analog PABX/KSU station mode	*5		
* Inhibit latching commands mode	*6		
Auxiliary contact mode (disables CCTV video control mode, factory default)	*7	+	#03
Auxiliary contact activation time .5-10 seconds (00 = .5 seconds/factory default)	2 digits (00-10)	+	#03
Auxiliary contact latched while either doorbox is activated	11	+	#03
** Auxiliary contact activated in custom ring cadence	12		
**CCTV video control mode (disables auxiliary contact mode)	*8		
Inhibit auxiliary ring cadence mode (useful with SLP-1)	*9		
To enter a single *	**		
To reset to factory settings	###		

CCTV Inactive (Idle State) Modes:

Description	Enter Digits	+	Location
Camera 1 and 2 output disconnected (factory default)	01	+	#04
Output camera 1	02	+	#04
Continue to output video from last camera activated	03	+	#04
Sequenced video from camera 1 and 2 (rotates every 4 seconds)	04	+	#04

* **Note:** Multiple modes may be selected. Except *4 and *5 which can not be used together.

** **Note:** Not compatible with Analog PABX/KSU Station mode.

C. Programming Examples

To Program the C-1000B...	Enter
1. ...to set door strike 1 to activate for 3 seconds	03 #01
2. ...to set the auxiliary contacts to activate an external ringer or strobe light in a custom ring cadence while either doorbox is ringing	12 #03
3. ...to have doorboxes ring phones in a custom ring pattern	*2
4. ...to have a door strike activation code be "55"	55#40
5. ...to have a door strike activation code be "7*"	7**#40

D. Door Strike Activation Code

The door strike activation code turns on the door strike relay for the programmed door strike activation time. The code can be entered while the phone is connected to a doorbox. The factory default activation code is "**". This can be changed to a different one or two-digit code. If a single-digit code is chosen, the available digits are 0-9. If a two-digit code is used the digits can be 0-9 and/or "*". Programming a "*" requires entering a "**" when in the programming mode. Note that the other commands listed in **Operation section D (Doorbox Controller Features)** remain the same, so do not program the door strike activation code to be the same as one of the other codes.

E. Security Code

This six digit number can be used to access the programming mode. The security code has been factory set to **845464** (V-I-K-I-N-G). It is recommended that you change the security code to a personal 6 digit number. To change the security code, access programming (see **Programming section A**). Enter six digits 0-9 followed by **#47**. If you have forgotten your security code, follow the steps in **Programming section A, 1. Accessing the**

8 Programming Mode Locally. *Note: The security code must be six digits in length and can NOT contain a * or #.*

F. DIP Switch Programming

Switch	Position	Description
1	OFF	Doorstrike Activation = 0.5 seconds (factory setting)
1	ON	Doorstrike Activation = 10 seconds
2	OFF	Normal Mode (factory setting)
2	ON	Security Code Bypass Mode
3	OFF	Line Concentrator Mode
3	ON	Normal Operation (factory setting)

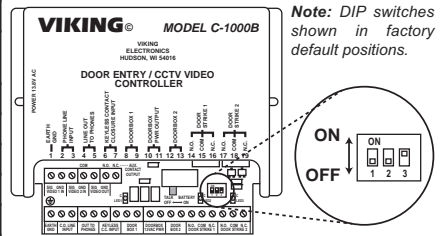

G. Mode Descriptions

Entering these codes while in programming will switch the **C-1000B** into the corresponding mode.

Disable Special Modes (*0): This command disables (clears) all the special modes listed below. Enter this command before programming the rest of the selections to be sure no unwanted modes are set.

Doorbell Mode (*1): In this mode, the ring signal from either doorbox is prevented from going through to the "LINE OUT TO PHONES" terminals. This is useful when a conventional door bell is connected to the auxiliary contacts. Now when someone activates a doorbox, the doorbell will chime rather than the phone ringing (see **Installation** section E).

Custom Ring Mode (*2): With this mode selected, the ring signal from the device ports are interrupted in a double burst pattern, making it easier to determine if the incoming call is from a doorbox or the C.O. line. **Note:** Some telephones and phone systems are not compatible with this feature.

Multiple Relay Activation Mode (*3): If selected, after a door strike command is entered, the phone is switched back to the doorbox port so additional doorstrike (relay activation) commands can be entered. This is useful when letting someone through your gate with the first command then unlocking your front doorstrike with a second command. To return to a call on hold, enter "#".

Paging Mode (*4): This mode is used for basic paging and/or existing installations using a **C-1000B** with a Viking paging amplifier such as the model **PA-2A**. For more information see **DOD# 485**. This mode is **NOT** for use with model **SLP-1**. For single line paging applications, the **SLP-1** is recommended, see **Installation** section B and see **DOD# 478**.

Analog PABX/KSU Station Mode (*5): This mode is ideal when installing the **C-1000B** on a phone system that does not have a spare trunk port but does have an unused analog station port. This mode allows any standard (POTS) telephone such as the **E-10A**, **E-20B**, **E-30** or **K-1700-3** to be used in place of Doorbox 1. Only one door phone can be used in this mode. When the door phone goes off-hook, a hot-line dialer or ringdown station will call the desired phone system extension. The phone on that extension can then communicate with the door phone and activate doorstrikes as needed (see **Installation** section H).

If the door strike activation code is changed from its default "**" to anything else, a five-second station timer takes effect. It starts when the person calling the PBX goes off-hook to start dialing. The function of this timer is to separate the extension dialing done by the caller in order to connect with the PBX from the touch tones used to control the door strike relay once connection is made. Touch tones that come before the timer is up are ignored by the **C-1000B**. Touch tones that come after the timer is up are detected and acted on by the unit. For this reason, it is important to keep in mind that touch tones meant to control the doorboxes should not be dialed immediately.

Note: Only a single door phone may be used. Multiple relay activation cannot be used with these Viking models: **E-10A**, **E-20B**, **E-30** or **K-1700-3**.

Inhibit Latching Commands Mode (*6): In some installations it is critical that the door strike or door actuator not be turned on for long periods of time. To prevent this from happening, enter *6 when in programming. In this mode, the toggle command (*#) and the continuous activation command (*1) are ignored.

Auxiliary Contact Mode (*7): See **Operation** section F.

CCTV Video Control Mode (*8): In this mode the **C-1000B** allows two CCTV video cameras to be concentrated down to one video signal, by switching to the camera at the zone/entry point being used. When the **C-1000B** detects a doorbox ringing or when a doorbox is monitored, it will connect that camera's video feed to the video output. When both doorboxes are inactive (idle), the **C-1000B** can be programmed to do one of four operations (see **Operation**, Section G). **Note:** The **CCTV Video Control Mode (*8)** is disabled when using the **Auxiliary Contact Mode (*7)**.

Inhibit Auxiliary Ring Cadence (*9): This mode is only applicable when using the Auxiliary Relay for Ring Cadence Activation. If a doorbox call comes in while a phone call is in progress, the phone received a call waiting tone. Because of this, it is unnecessary (and likely interruptive), for additional chimes to be triggered. When this is the case, this mode can be used to inhibit the auxiliary relay from triggering additional chime sounds (ie. from an **SLP-1**), when a phone call is in progress. When the phone line is not in use, the auxiliary relay will still provide ring cadence activation.

A. Communicating with the Doorbox

1. Visitor Initiated Call

A visitor pressing the “Call” button will cause the phones connected to the “**LINE OUT TO PHONES**” terminals to ring. Simply answer your phone to converse with the visitor. After answering the call, a single or double beep will be heard in the phone, indicating which doorbox has called - a single beep for doorbox 1 and a double beep for doorbox 2.

2. Monitoring Doorboxes

A doorbox may be monitored from any phone connected to the **C-1000B** by Touch Tone dialing a “#” followed by a Touch Tone “1” or “2” to monitor doorbox 1 or doorbox 2 respectively. This feature is not available for pulse dialing phones. **Note: Do not attempt doorbox monitoring while a call is in progress, the call will be disconnected. Note: When monitoring, the auxiliary contact will only work in the Continuous Mode (11 # 03).**

B. Placing C.O. Line Calls on Hold

If a C.O. line call is in progress and a doorbox is activated, a single or double “call waiting” tone will be heard indicating doorbox 1 or doorbox 2 is calling. To place the in-progress call on hold and answer the calling doorbox, simply dial a Touch Tone “#”, pulse dial a “2” or hook flash twice.

C. Activating a Doorstrike, Magnetic Lock or Gate Controller

To activate a relay contact, you must be communicating with a doorbox. Touch Tone dial the door strike activation code (default is “**”), pulse dial a “3” or hook flash three times. Two confirmation tones will be heard and the relay will be activated for the programmed doorstrike activation time. The phone will then be returned to the C.O. line. If a call was in progress, the original caller will be taken off hold to continue the conversation. To return to the original call without activating a relay, Touch Tone dial “#”, pulse dial a “2” or hook flash twice.

D. Doorbox Controller Features

Doorbox Controller Feature Description	Touch Tone Commands	* Pulse Dial/Flash Commands
Momentarily activate doorstrike relay 1 or 2 (Programmable)	* * or _ _	Pulse dial 3 or hook flash 3 times
Continuously activate (latch) doorstrike relay 1 or 2	* 1	
Continuously de-activate (unlatch) doorstrike relay 1 or 2	* 0	
Activate opposite doorstrike relay	* 2	
Toggle relay from last position	* #	
Answer or disconnect a doorbox call	#	Pulse dial 2 or hook flash 2 times
Monitor doorbox 1	# 1	
Monitor doorbox 2	# 2	

Note: For “Momentarily activate door strike relay 1 or 2” in the above table, the default code “**” is shown. This code is programmable; see **Programming** section **D** (Door Strike Activation Code).

Note: When on the C.O. line, if a Touch Tone other than # is entered, any additional Touch Tones in that dial string will be ignored. To regain control of the **C-1000B**, the phone must be momentarily placed on-hook.

* **Note:** Pulse dialing and flash commands are not compatible in the “Multiple Relay Activation” mode.

E. Keyless Entry/Postal Lock

When a momentary postal lock contact closure is made across terminals **6 & 7** (see **Installation** section **D**), the doorstrike 1 contact will activate for the programmed time.

F. Auxiliary Contact Mode (*7)

The auxiliary contacts are a separate set of contacts that can be programmed (see **Programming section B**) to activate in different patterns when doorbox 1 or doorbox 2 is activated. A momentary activation, a continuous activation while the doorbox is in use, and a ring cadence pattern are available.

Note: *The auxiliary contact mode (*7) is disabled when using the **CCTV Video Control Mode (*8)**.*

- 1. Timed Activation:** If an auxiliary contact activation time is programmed (two digits **00-10** followed by **#03**), when either doorbox is activated, the auxiliary contacts will activate for the programmed time (.5 - 10 seconds). This is ideal for operating a doorbell or chime.
- 2. Continuous Activation:** If the auxiliary contact is programmed to continuously activate (**11** followed by **#03**), while either doorbox is ringing or in use, the auxiliary contacts will latch. This is ideal for controlling lights, etc.
- 3. Ring Cadence Activation:** If the auxiliary contact is programmed to custom ring cadence ("**12 #03**") when doorbox 1 is activated, a repeating 1 second on and 3 seconds off contact pattern is generated. If doorbox 2 is activated, a repeating double burst contact pattern is generated with 3 seconds off between patterns. If ring cadence activation is programmed and the **C-1000B** is used with a Viking **SLP-1** (see **Installation section B**) to produce unique front and back door chimes, the chimes can be disabled while a CO call is in progress if desired. This is done by entering (*9) while in programming. **Note:** *Ring cadence activation is not compatible with the Analog PABX/KSU Station mode.*

G. Doorbox Triggered CCTV Camera Switching / CCTV Video Control Mode (*8)

The **C-1000B** allows two CCTV video cameras to be concentrated down to one video signal, by switching to the camera at the zone/entry point being used. When the **C-1000B** detects doorbox ringing or when a doorbox is monitored it will connect that camera's video feed to the video output. This happens in a first come, first serve manner. When both doorboxes are inactive (idle) the **C-1000B** can be programmed to do one of four operations (see **Programming section B**):

1. Disconnect all cameras so there is no video output (**01#04**). This mode is very convenient when used in combination with a switching video RF modulator, which automatically switches the video source in when a video signal is present. A home TV's broadcast/satellite program will be automatically interrupted to show video feed of the arriving guest (see **Installation section A**).
2. Connect video feed from camera 1 (**02#04**).
3. Remain connected to the camera near the last doorbox activated and continue feeding video, until the other doorbox is activated (**03#04**).
4. Sequence video from both cameras, rotating every 4 seconds (**04#04**).

Note: *The CCTV Video Control Mode (*8) is disabled when using the Auxiliary Contact Mode (*7).*

Warranty

IF YOU HAVE A PROBLEM WITH A VIKING PRODUCT, CONTACT: VIKING TECHNICAL SUPPORT AT (715) 386-8666

Our Technical Support Department is available for assistance Monday through Friday 8am - 5pm central time. So that we can give you better service, before you call please:

1. Know the model number, the serial number and what software version you have (see serial label).
2. Have your Product Manual in front of you.
3. It is best if you are on site.

RETURNING PRODUCT FOR REPAIR

The following procedure is for equipment that needs repair:

1. Customer must contact Viking's Technical Support Department at 715-386-8666 to obtain a Return Authorization (RA) number. The customer MUST have a complete description of the problem, with all pertinent information regarding the defect, such as options set, conditions, symptoms, methods to duplicate problem, frequency of failure, etc.
2. Packing: Return equipment in original box or in proper packing so that damage will not occur while in transit. Static sensitive equipment such as a circuit board should be in an anti-static bag, sandwiched between foam and individually boxed. All equipment should be wrapped to avoid packing material lodging in or sticking to the equipment. Include ALL parts of the equipment. C.O.D. or freight collect shipments cannot be accepted. Ship cartons prepaid to: **Viking Electronics, 1531 Industrial Street, Hudson, WI 54016**
3. Return shipping address: Be sure to include your return shipping address inside the box. We cannot ship to a PO Box.
4. RA number on carton: In large printing, write the R.A. number on the outside of each carton being returned.

RETURNING PRODUCT FOR EXCHANGE

The following procedure is for equipment that has failed out-of-box (within 10 days of purchase):

1. Customer must contact Viking's Technical Support at 715-386-8666 to determine possible causes for the problem. The customer MUST be able to step through recommended tests for diagnosis.
2. If the Technical Support Product Specialist determines that the equipment is defective based on the customer's input and troubleshooting, a Return Authorization (R.A.) number will be issued. This number is valid for fourteen (14) calendar days from the date of issue.
3. After obtaining the R.A. number, return the approved equipment to your distributor, referencing the R.A. number. Your distributor will then replace the Viking product using the same R.A. number.
4. The distributor will NOT exchange this product without first obtaining the R.A. number from you. If you haven't followed the steps listed in 1, 2 and 3, be aware that you will have to pay a restocking charge.

TWO YEAR LIMITED WARRANTY

Viking warrants its products to be free from defects in the workmanship or materials, under normal use and service, for a period of two years from the date of purchase from any authorized Viking distributor. If at any time during the warranty period, the product is deemed defective or malfunctions, return the product to Viking Electronics, Inc., 1531 Industrial Street, Hudson, WI., 54016. Customer must contact Viking's Technical Support Department at 715-386-8666 to obtain a Return Authorization (R.A.) number.

This warranty does not cover any damage to the product due to lightning, over voltage, under voltage, accident, misuse, abuse, negligence or any damage caused by use of the product by the purchaser or others. This warranty does not cover non-EWP products that have been exposed to wet or corrosive environments. This warranty does not cover stainless steel surfaces that have not been properly maintained.

NO OTHER WARRANTIES. VIKING MAKES NO WARRANTIES RELATING TO ITS PRODUCTS OTHER THAN AS DESCRIBED ABOVE AND DISCLAIMS ANY EXPRESS OR IMPLIED WARRANTIES OR MERCHANTABILITY OR FITNESS FOR ANY PARTICULAR PURPOSE.

EXCLUSION OF CONSEQUENTIAL DAMAGES. VIKING SHALL NOT, UNDER ANY CIRCUMSTANCES, BE LIABLE TO PURCHASER, OR ANY OTHER PARTY, FOR CONSEQUENTIAL, INCIDENTAL, SPECIAL OR EXEMPLARY DAMAGES ARISING OUT OF OR RELATED TO THE SALE OR USE OF THE PRODUCT SOLD HEREUNDER.

EXCLUSIVE REMEDY AND LIMITATION OF LIABILITY. WHETHER IN AN ACTION BASED ON CONTRACT, TORT (INCLUDING NEGLIGENCE OR STRICT LIABILITY) OR ANY OTHER LEGAL THEORY, ANY LIABILITY OF VIKING SHALL BE LIMITED TO REPAIR OR REPLACEMENT OF THE PRODUCT, OR AT VIKING'S OPTION, REFUND OF THE PURCHASE PRICE AS THE EXCLUSIVE REMEDY AND ANY LIABILITY OF VIKING SHALL BE SO LIMITED.

IT IS EXPRESSLY UNDERSTOOD AND AGREED THAT EACH AND EVERY PROVISION OF THIS AGREEMENT WHICH PROVIDES FOR DISCLAIMER OF WARRANTIES, EXCLUSION OF CONSEQUENTIAL DAMAGES, AND EXCLUSIVE REMEDY AND LIMITATION OF LIABILITY, ARE SEVERABLE FROM ANY OTHER PROVISION AND EACH PROVISION IS A SEPARABLE AND INDEPENDENT ELEMENT OF RISK ALLOCATION AND IS INTENDED TO BE ENFORCED AS SUCH.

FCC REQUIREMENTS

This equipment complies with Part 68 of the FCC rules and the requirements adopted by the ACTA. On the side of this equipment is a label that contains, among other information, a product identifier in the format US:AAAEQ##TXXXX. If requested, this number must be provided to the telephone company.

The REN is used to determine the number of devices that may be connected to a telephone line. Excessive REN's on a telephone line may result in the devices not ringing in response to an incoming call. In most but not all areas, the sum of the REN's should not exceed five (5.0). To be certain of the number of devices that may be connected to a line, as determined by the total REN's, contact the local telephone company. For products approved after July 23, 2001, the REN for this product is part of the product identifier that has the format US:AAAEQ##TXXXX. The digits represented by ## are the REN without a decimal point (e.g., 03 is a REN of 0.3). For earlier products, the REN is separately shown on the label.

The plug used to connect this equipment to the premises wiring and telephone network must comply with the applicable FCC Part 68 rules and requirements adopted by the ACTA. If your home has specially wired alarm equipment connected to the telephone line, ensure the installation of this C-2000B does not disable your alarm equipment. If you have questions about what will disable alarm equipment, consult your telephone company or a qualified installer.

If the C-1000B causes harm to the telephone network, the telephone company will notify you in advance that temporary discontinuance of service may be required. But if advance notice isn't practical, the telephone company will notify the customer as soon as possible. Also, you will be advised of your right to file a complaint with the FCC if you believe it is necessary.

The telephone company may make changes in its facilities, equipment, operations, or procedures that could affect the operation of the equipment. If this happens, the telephone company will provide advance notice in order for you to make the necessary modifications to maintain uninterrupted service.

If trouble is experienced with the C-1000B, for repair or warranty information, please contact:

Viking Electronics, Inc., 1531 Industrial Street, Hudson, WI 54016 (715) 386-8666

If the equipment is causing harm to the telephone network, the telephone company may request that you disconnect the equipment until the problem is resolved.

Connection to Party Line Service is subject to State Tariffs. Contact the state public utility commission, public service commission or corporation commission for information.

WHEN PROGRAMMING EMERGENCY NUMBERS AND (OR) MAKING TEST CALLS TO THE EMERGENCY NUMBERS:

Remain on the line and briefly explain to the dispatcher the reason for the call. Perform such activities in the off-peak hours, such as early morning or late evenings.

It is recommended that the customer install an AC surge arrester in the AC outlet to which this device is connected. This is to avoid damaging the equipment caused by local lightning strikes and other electrical surges.

PART 15 LIMITATIONS

This equipment has been tested and found to comply with the limits for a Class A digital device, pursuant to Part 15 of the FCC Rules. These limits are designed to provide reasonable protection against harmful interference when the equipment is operated in a commercial environment. This equipment generates, uses, and can radiate radio frequency energy and, if not installed and used in accordance with the instruction manual, may cause harmful interference to radio communications. Operation of this equipment in a residential area is likely to cause harmful interference in which case the user will be required to correct the interference at his own expense.

Due to the dynamic nature of the product design, the information contained in this document is subject to change without notice. Viking Electronics, and its affiliates and/or subsidiaries assume no responsibility for errors and omissions contained in this information. Revisions of this document or new editions of it may be issued to incorporate such changes.