

VIKING PRODUCT MANUAL

SECURITY & COMMUNICATION SOLUTIONS

12 Button Apartment Entry Phone with Built-In Door Strike Relay and Proximity Card Reader

The **K-1270** Entry Phone is a two-way, handsfree telephone with 12 buttons for calling individual residences in an apartment building with an integrated 125 KHz Proximity Card Reader. The rugged stainless steel faceplate has a printed directory housed in a waterproof, scratch-resistant lens. Each button is beside the tenants name in the directory so there are no confusing codes to deal with. Calling a particular tenant is as easy as pressing a single button. The **K-1270** has a built in speed dialer that can handle up to 12 primary phone numbers, each with 22 digits. If there is no answer at the first number, a second number can be called automatically. Once the tenant answers their phone, a single touch tone command can activate the door strike relay. For "no phone line" applications, the **K-1270** is compatible with the **C-3000** no CO (phone line) controller.

The **K-1270-EWP** shares all of the features of the **K-1270** in addition to Enhanced Weather Protection (EWP) for outdoor installations where the unit is exposed to precipitation or condensation. EWP products feature foam rubber



"Brushed 316 Stainless Steel"
(similar to brushed nickel)



(shown in optional
VE-5x10-SS, not included)

gaskets and boots, sealed connections, gel-filled butt connectors, as well as urethane or thermal plastic potted circuit boards with internally sealed, field-adjustable trim pots and DIP switches for easy on-site programming.

Features

- Built-in 125KHz 26-bit Wiegand proximity card reader with LED, beep card read confirmation, and EWP board protection
- Compatible with the following Viking Proximity Cards and Fobs: **PRX-C**, **PRX-C-ISO** and **PRX-FOB (DOD# 198)**
- **Vandal Resistant Features:** 14 gauge louvered 316 stainless steel faceplate with permanent laser etched graphics, heavy duty metal keypad and T-10 Torx Security mounting screws.
- **Weather Resistant Features:** Marine grade 316 stainless steel faceplate and screws. Internally sealed keypad. Mylar speaker. Self-draining mic mount. Faceplate, keypad, mic and speaker gaskets.
- Designed to meet IP66 Ingress Protection Rating (see **DOD 859**)
- Operates on 12 to 24 volts AC/DC
- 12 speed dial buttons (22 digits each)
- 12 alternate number positions (22 digits each)
- One button operation (no call button)
- Hang up on CPC, busy, silence, time-out or dial tone
- Touch tone restriction from microphone
- Integral relays for camera control and door strike
- Works with **C-1000B** for increased security
- Works with **C-3000** for "No CO" (phone line) operation
- 50 keyless entry codes
- See model **K-1205** for integral camera
- Postal lock input
- Optional **VE-5x10** surface mount box, sold separately (**DOD 424**)

Applications

- Small apartment buildings
- Professional buildings
- Gated communities

www.vikingelectronics.com
Information: (715) 386-8861

Specifications

Power: 12 to 24 Volts AC or DC, 12VDC adapter provided
Proximity Card Reader Power: 5 to 14V DC @ 60mA maximum
Note: To assure operation during a power outage, a UPS should be used.

Dimensions: 127mm x 254mm x 63.5mm (5" x 10" x 2.5")
Shipping weight: 2.2 kg (4.8 lbs.)

Standard K-1270 Environment: -34° C to 65° C (-30° F to 150° F) with 5% to 95% non-condensing humidity
K-1270-EWP Environment: -34° C to 65° C (-30° F to 150° F) with up to 100% condensing humidity

Relay Contact Rating:

Door Strike: 5A @ 30VDC/250VAC maximum
Camera: 0.5A @ 125 VAC, 1.0A @ 30VDC

Connections: (16) gel-filled butt connectors (3M Scotchlok UR2)

Proximity Card Reader Specifications

Power: 5 to 14V DC @ 60mA maximum

Maximum Cable Length: 500 ft 24 Awg stranded shielded (Belden 9537)

Frequency: 125KHz

Format: 26 bit Wiegand

Read Range: 1.25" to 2.0"

Technologies Supported: Viking PRX-C, PRX-C-ISO, PRX-FOB, LRT-4, certain legacy HID® proximity protocols* and certain AWID 125KHz proximity protocols**

Transducer: Beeps during card read

LED: Red, turns off during card read

Humidity: Up to 100% (fully potted EWP)

Operating Temperature: -34° C to 65° C (-30° F to 150° F)

* HID and the HID logo are registered trademarks of HID Global Corporation, an ASSA ABLOY company. All other trademarks are the property of their respective owners.

** AWID is a trademark of Applied Wireless Identification Group.

Features Overview

Front View of the K-1270 Entry Phone

Mounting Screws: (8) 6-32 X 3/4" Marine grade 316 stainless steel, flat head, T-10 Torx security screws and drive bit (included).

Microphone: Omni-directional microphone with protective water-resistant cloth.

Blue Call LED: Lights steady to help locate the button in low light.

Faceplate Material: 14 gauge 316 stainless steel with #4 brushed finish.

Laser Etched Graphics: For long lasting easy to read graphics.

Speaker: Mylar speaker with rubber gasket to maintain water-tight seal and eliminate water deterioration.

Speaker Screen: Speaker screen with 0.018" wide slots to prevent punctures from paperclips, etc.

Proximity Card Reader: 26-bit Wiegand, 125KHz, red LED turns off and transducer will beep during card read. Fully potted EWP. Read range 1.25" to 2.0". Impact resistant polycarbonate lens with water-tight gasket.

Keypad: Push to initiate call, push again to disconnect. Zinc Die cast with Satin Chrome Finish, internally sealed per IP67.

Condensation Drain Hole

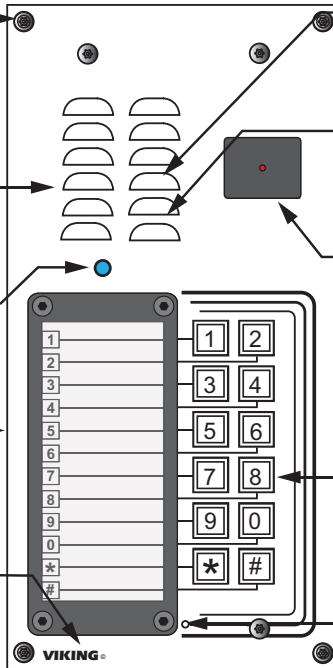

Installation



IMPORTANT: Electronic devices are susceptible to lightning and power station electrical surges from both the AC outlet and the telephone line. It is recommended that a surge protector be installed to protect against such surges.

A. Mounting

The **K-1270** is designed to be installed in a sheltered location, and is not meant to be used outdoors. For outdoor applications use the **K-1270-EWP**. The **K-1270** can either be installed as a flush mount unit using the included rough in box, or as a surface mount unit using an optional **VE-5x10**. The rough in box uses the inner set of four holes on the face plate while the **VE-5x10** uses the outside set of holes. A set of dummy screws and nuts are provided to fill the unused mounting holes.

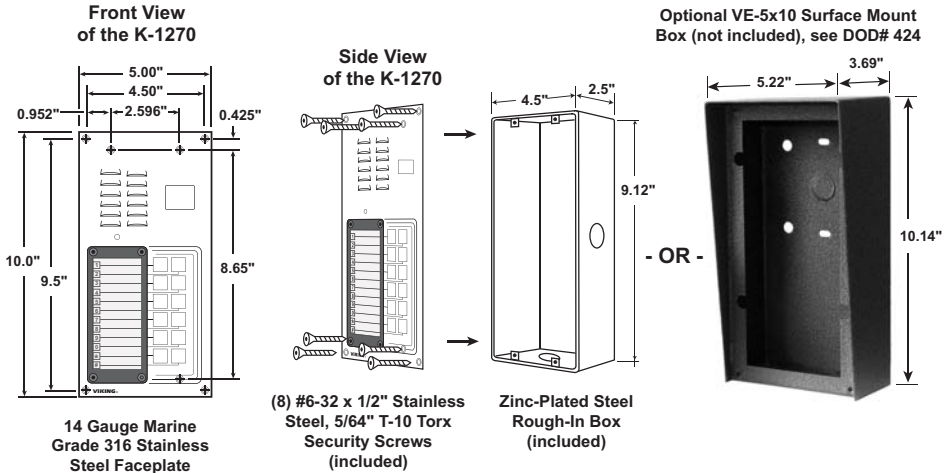

B. Changing the Directory

To install a directory, remove the four screws that mount the directory lens to the front of the **K-1270** using the included Allen wrench. Insert a paper directory behind the lens and secure the two back onto the front panel being careful to align the names with the front panel graphics. For your convenience, the back of this document has pre-printed directory forms.

Note: To print directory forms for the **K-1270**, go to www.vikingelectronics.com and enter "930" in the DOD field at the top of the page for a direct link to the PDF.

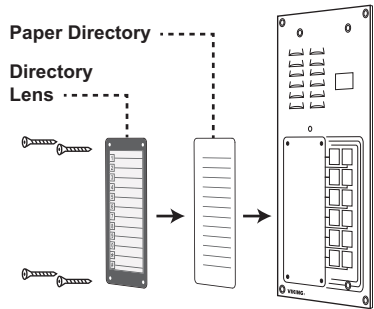

C. Wiring

The **K-1270** can be powered from any source supplying 12 to 24 volts, AC or DC. A 12 volt DC adapter is supplied with the product. When using the included adapter, the plug on the adapter cord will have to be removed. The power connections to the **K-1270** (black wires) are not polarity sensitive.

There are also 8 more wires connected to the **K-1270** controller board. Two wires are for the incoming phone line, three are from the high current door strike relay and the last three are from the camera relay. Gel filled butt connectors are provided for easier connection to building wiring. The table at the right describes each wire's function.

Color	Function
Black	Power In
Black	Power In
Green	Phone Line In
Red	Phone Line In
Brown	Door Strike Relay common
Orange	Door Strike Relay NC
Yellow	Door Strike Relay NO
Blue	Camera Relay common
Violet	Camera Relay NC
White	Camera Relay NO

D. Wiring the K-1270 Proximity Card Reader



IMPORTANT: Electronic devices are susceptible to lightning and power station electrical surges from both the AC outlet and the telephone line. It is recommended that a surge protector be installed to protect against such surges.

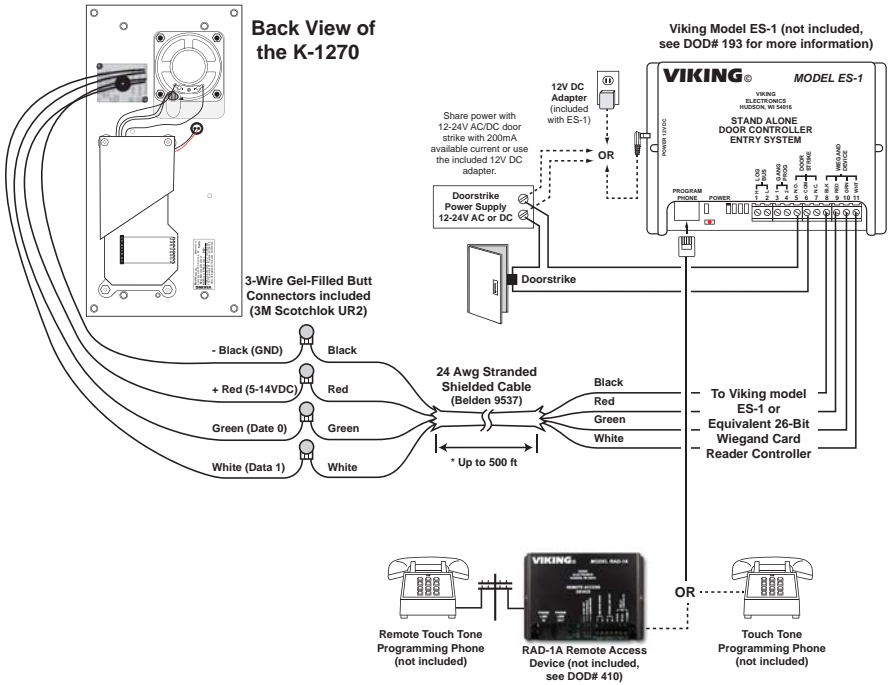

Important: To operate the K-1270 during a power failure, a UPS should be installed.

A. Connecting a Doorstrike to the K-1270 Internal Relay

The K-1270 provides a dry contact output that can be used for operation of a door strike. To use this feature, the Door Strike Code and Door Strike Time must be set in programming. In this mode, when the Door Strike Code is detected, the K-1270 will energize the relay for the period of time selected in the Door Strike Time (see Programming section E, G and H).

If a Postal Lock is required, connect the normally open contacts of the lock to the two white wires coming from the two pin connector on the lower portion of the control board. When the postal lock is momentarily actuated, the door strike will energize for the programmed Door Strike Time.

*** Note:** To prevent unwanted radio interference, route the connecting wires through the included ferrite core.

**** Note:** The gel-filled (water-tight) butt connectors are designed for insulation displacement on 19-26 gauge wire with a maximum insulation of 0.082 inches. Cut off stripped ends prior to terminating.

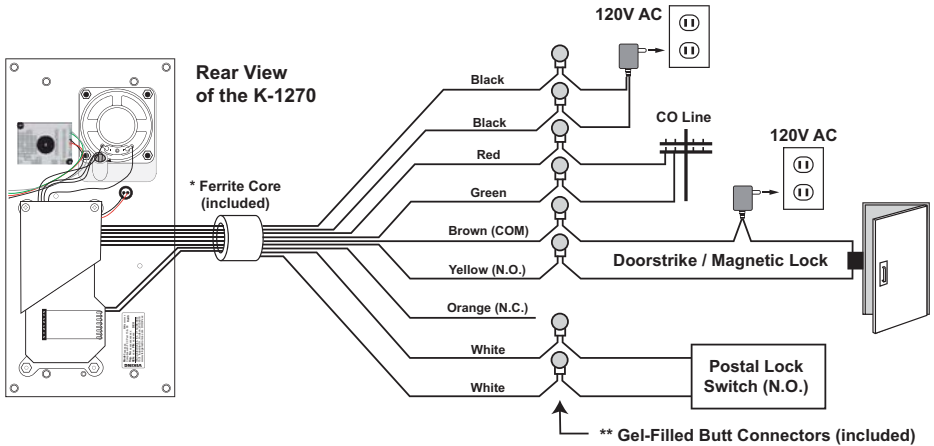

B. Connecting Camera Control to the K-1270 Internal Relay

Another internal relay in the K-1270 can be used to trigger a camera controller. When the K-1270 makes a call, it will energize the relay and hold it on until the call is done.

*** Note:** To prevent unwanted radio interference, route the connecting wires through the included ferrite core.

**** Note:** The gel-filled (water-tight) butt connectors are designed for insulation displacement on 19-26 gauge wire with a maximum insulation of 0.082 inches. Cut off stripped ends prior to terminating.

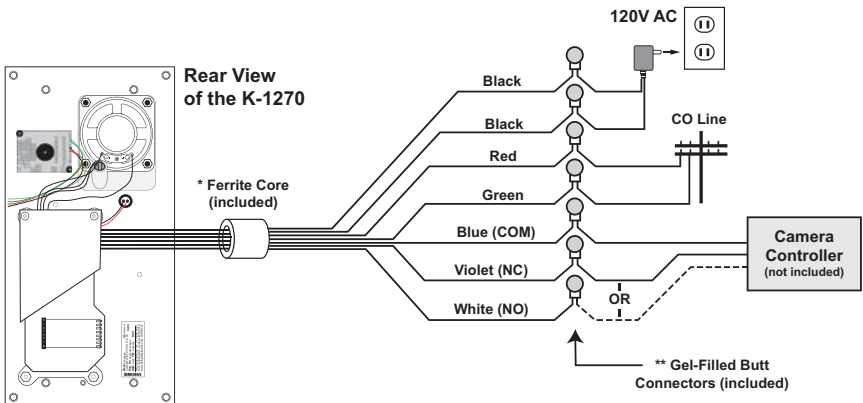

C. Using the K-1270 with a C-1000B

In some instances it may be a concern that the Door Strike relay is outside the door. In this situation, a second controller such as a **C-1000B** can be used. Be sure to disable the door strike code for the **K-1270** (see **Programming** section H).

- Notes:**
1. The **C-1000B** must be in the "Analog Station Mode" (refer to the **C-1000B** Product Manual).
 2. The **K-1270** keyless entry codes can not be used in this application.
 3. The **K-1270** will hang up during doorstrike activation.

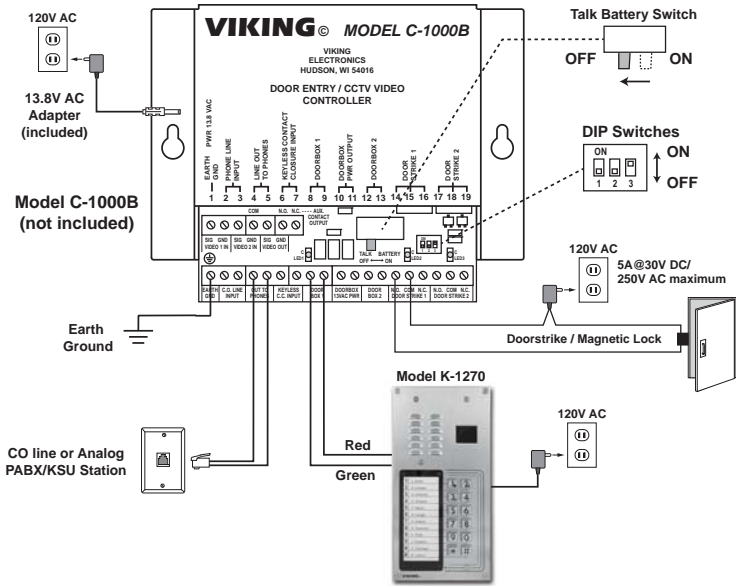

D. Using the K-1270 with a C-3000

For a "No CO" installation, a Viking **C-3000** No CO controller can be used with the **K-1270**. Note, the **K-1270** will need to be programmed on a separate CO line or use the Viking **DLE-200B**. The door strike can be controlled by the **K-1270** or the internal relay on the **C-3000**, just be sure to disable the door strike feature in the other unit. The keyless entry feature of the **C-3000** can not be used. If not using keyless entry codes, use the **C-3000** to control the doorstrike. If using keyless entry codes (up to 50), use the **K-1270** to control the doorstrike. The **K-1270** speed dial position should be programmed with the **C-3000** line selection command "1" to "12". (Refer to the **C-3000** Technical Practice for more details, DOD# 162).

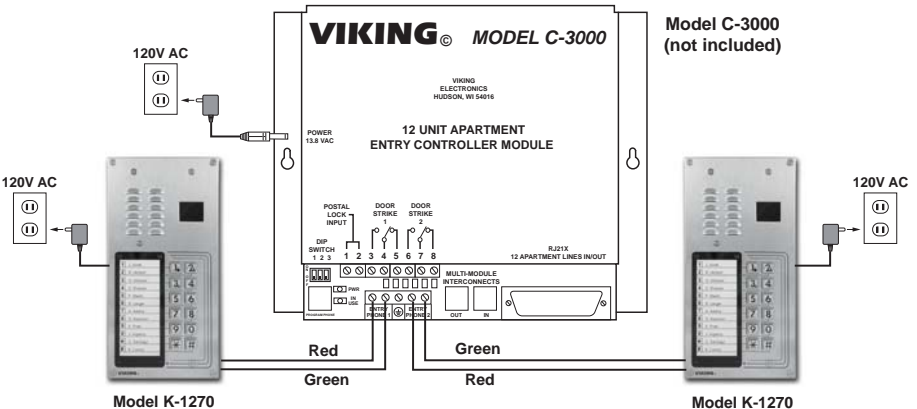

- Notes:**
1. In this application, the **C-3000** keyless entry feature is not available. Use the keyless entry feature of the **K-1270** and wire both door strike relays in parallel.
 2. The **K-1270** will hang up during the doorstrike activation.

E. Add Relay Control for up to 4 K-1270/75 Proximity Card Readers

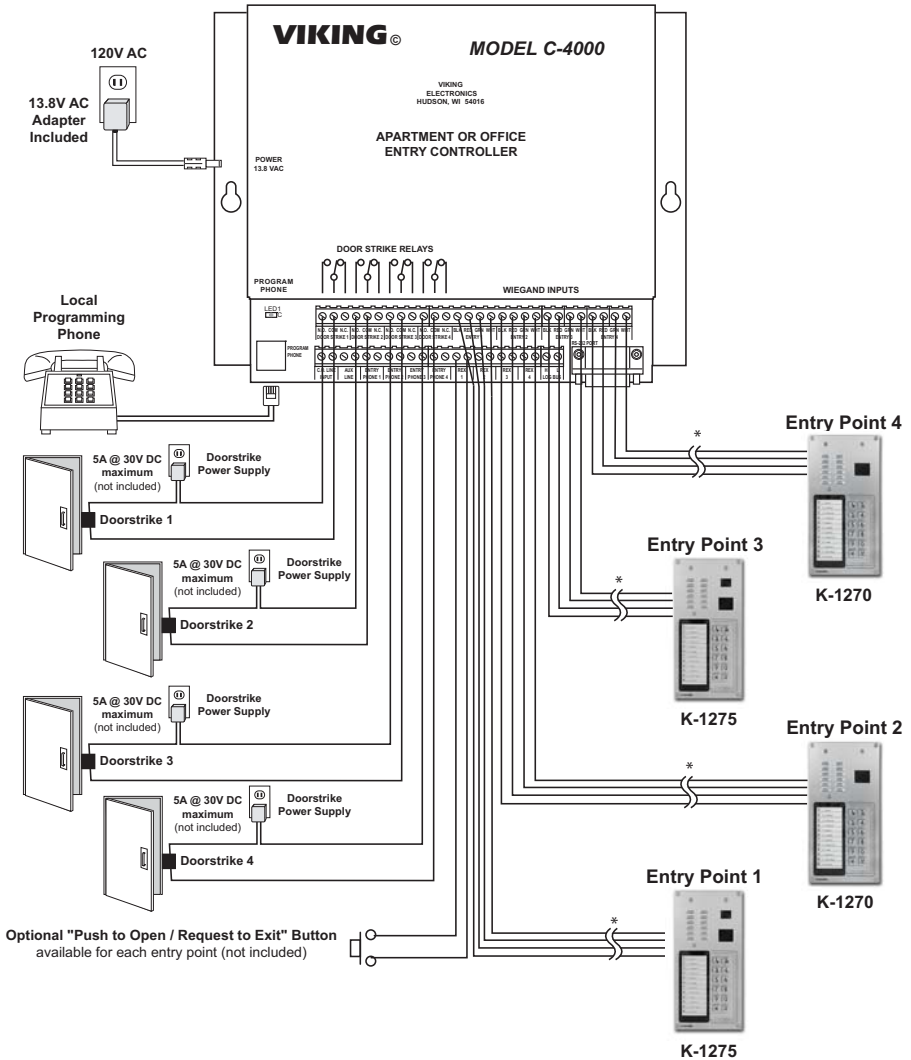

IMPORTANT: Electronic devices are susceptible to lightning and power station electrical surges from both the AC outlet and the telephone line. It is recommended that a surge protector be installed to protect against such surges.

* **Note:** Maximum Wiegand run length is 300 feet using 24 gauge wire. Run length is reduced to half if two share the same wire run from the same **C-4000** entry point. Run lengths can be doubled by doubling up on the **BLACK** and **RED** 24 gauge wire, or using 21 gauge (or larger) wire. Certain electrically noisy locations might require shielded wire.

A. Accessing the Programming Mode

1. Accessing the Programming Mode with the Security Code

Step 1	Move DIP switch 1 to the ON position (sets unit to answer incoming calls).
Step 2	From a touch tone phone, call the line attached to the K-1270 .
Step 3	When the K-1270 answers, listen for the beep(s) and then enter a “#” followed by the 6-digit security code (factory set to 845464). A double beep should be heard indicating you have entered the programming mode.

2. Accessing the Programming Mode without the Security Code

Step 1	Move DIP switch 1 to the ON position (sets unit to answer incoming calls).
Step 2	Move DIP switch 4 to the ON position (incoming calls enter programming without security code, see section B).
Step 3	From a touch tone phone call the line attached to the K-1270 .
Step 4	When the K-1270 answers, a double beep should be heard indicating you have entered the programming mode.
Step 5	When finished programming, move DIP switch 4 back to the OFF position.

3. Forced Answer to Enter Programming

If the ring signal produced by the central office is non-standard or of low amplitude, the **K-1270** might not detect ring and answer the line, which would prevent the user from entering programming. If this happens, check to see that DIP switch 1 is ON so the unit is set to answer incoming calls. Then turn DIP switch 4 ON to allow accessing programming without the security code. Call the line attached to the **K-1270**. With the phone ringing, press the “0” button on the **K-1270** keypad. The **K-1270** should answer the line and you should hear two beeps indicating that you are in the programming mode. To leave programming, just hang up, or enter “##7” to disconnect the line immediately. Be sure to turn DIP switch 4 OFF when through with programming.

B. Security Code (memory location #47)

This six digit number can be used to access the programming mode. The security code has been factory set to **845464** (V-I-K-I-N-G). It is recommended that you change the security code to a personal 6 digit number. To change the security code, access programming (see **Programming** section A). Enter six digits 0-9 followed by **#47**. If you have forgotten your security code, follow the steps in **Programming** section A, **2. Accessing the Programming Mode Without the Security Code**). **Note:** The security code must be six digits in length and can NOT contain a * or #.

C. Access Code (memory location #48)

The access code comes into play when Tenant Initiated Entry is enabled (see **Operation**). It is a 1 to 6 digit code making it possible for tenants to allow a visitor to enter in the special case where the tenant calls the **K-1270** and converses with the visitor rather than the visitor starting the entry process by pressing a directory button. The access code has been factory set to **123456**. It is recommended that you change the access code to a personal 1-6 digit number. To change the access code, enter programming (see **Programming** section A). Enter 1-6 digits followed by **#48**. To disable the access code, enter just **#48** without any preceding digits. Note that disabling the access code removes a level of security (see **O. Tenant Initiated Entry**). Also note that an access code is required only if Tenant Initiated Entry is allowed (see **Programming** section O).

D. Keyless Entry Codes

The **K-1270** can be programmed with up to 50 keyless entry codes. This feature allows a visitor to let themselves in by entering a preprogrammed code on the **K-1270** keypad. Each keyless code can contain from 1 to 6 digits and is programmed by entering the digits into any of the locations **#50** to **#99**. To clear a location enter “#” followed by the position number without any preceding number. The “*” and “#” keys can also be used in the keyless codes by substituting “#20” and “#21” (respectively) when programming a keyless position.

E. Quick Programming Features

The **K-1270** is programmed through the incoming phone line. The programming commands are structured so that they do not interfere with the commands of a **C-1000B** controller.

Description	Enter Digits	+ Location
Speed dial numbers	0-46 digits**	+ #01 - #12
Door strike time in sec (factory 05, 00 =.5 sec)*	2 digits	+ #40
Door strike code (factory 6, no digits disables)	1-2 digits	+ #41
Maximum call time in min (factory 3, 0 = .5 min, no digits disables)*	1 digit	+ #42
Maximum ring time in sec (factory 20, 00 disables)*	2 digits	+ #43
Silence Time Out in sec (factory 10, 00 disables)*	2 digits	+ #44
Talk/listen delay time in .1 sec (factory 2)*	1 digit	+ #45
Security code (factory 845464)*	6 digits	+ #47
Access code (factory set to 123456)*	1-6 digits	+ #48
Keyless entry codes	1-6 digits	+ #50 - #99
Dial a (*)	#20	
Dial a (#)	#21	
Add a 4 second pause	#22	
Add a 1 second pause	#23	
Second phone number selector	#24	
Normal dialing speed (factory setting)	#30	
Fast dialing speed	#31	
Hang up on dial tone enable (factory setting)	#32	
Hang up on dial tone disable	#33	
Disable tenant initiated entry (factory setting)	#37	
Enable tenant initiated entry	#38	
Reset all programming to factory default settings	###	
Hang up from programming	##7	

* Cannot contain "*" or "#" (see #20 and #21) ** 45 digits maximum if two numbers are programmed in one memory location

- Notes:**
1. A single or double beep indicates a valid entry, three beeps indicate an error.
 2. "*" or "#", pauses or second phone number selector occupy one digit of memory.

F. Speed Dial Numbers

The **K-1270** Entry Controller can be programmed with up to twelve 46 digit numbers. Each number can also be programmed with special features such as pauses, and the Touch Tones "*" and "#". Each of the special characters count as a single digit. Each of the speed dial positions #01 to #12 pertain to the corresponding button on the front of the **K-1270**. The button "0" uses position #10, the "*" uses position #11 and the "#" uses position #12. To program a speed dial position, enter programming (see section A) then enter the desired number followed by the selected position. To clear a position, only enter a "#" followed by the position number with out any preceding number.

The **K-1270** also has the capability to dial a second phone number if there is no answer or busy at the first number. This can be used if the tenant wants the visitor to call their cell phone if they are not at home. To program a second number, be sure that position #43 is programmed with the desired maximum ring time, then enter the first number to be dialed, followed by "#24". A single beep should be heard. Next enter the second number to be dialed followed by "#" plus the memory location. The total number of digits cannot exceed 46 for each position (45 digits if two numbers are programmed). The following are examples of speed dial number entries:

To Program the K-1270 to...	Step 1 (see section A)	Step 2 - Enter Digits
...store 555-1234 at the first button position	Enter programming	5551234#01
...store a 9, a 1 second pause, then 333-4444 in the seventh button position	Enter programming	9#233334444#07
...store a 23*# in the eight position	Enter programming	23#20#21#08
...store a first number of 22 and a second number of 33 in the "#" button position	Enter programming	22#24 (beep) 33#12

G. Door Strike Time

The actual time the door strike relay is energized is controlled by location #40. The time can be set from 00 to 99 seconds, (an entry of "00" gives 0.5 seconds). In order to use this feature, be sure the relay door strike code is set (see section H).

H. Door Strike Code

A one or two digit door strike code can be entered by programming position #41. When in programming, enter the one or two digit code followed by "#41". **Note:** "*" and "#" can be entered as valid characters of the door strike code by substituting "#20" and "#21" (respectively) when programming the door strike code (see section D). To disable the door strike relay, enter "#41" without any preceding numbers. Examples of door strike code entries are shown to the right.

To Program the Door Strike Code to...	Step 1 (see section A)	Step 2 Enter Digits
"99"	Enter programming	99#41
"3"	Enter programming	3#41
"*#"	Enter programming	#20#20#41
"#1"	Enter programming	#211#41
"*"	Enter programming	#20#41

I. Maximum Call Time

In some installations, it may be desirable to limit the length of the call to the tenant. This can be done by programming position **#42**. The maximum call time can be set from 1 minute to 9 minutes by entering the appropriate number in position **#42**. A "0" will yield a 30 second time. To disable the call timer enter "**#42**" without any preceding digit.

J. Maximum Ring Time

This timer sets the maximum amount of time the **K-1270** will look for the call to be answered. If this timer expires and the tenant has not answered, the call will be terminated or the **K-1270** will dial a second phone number (if programmed). The factory setting is 20 seconds, and to disable this feature, enter "**00**" into position 43.

K. Silence Time Out

This time out is started once the call has been connected and is reset every time audio is detected on the phone line. If it expires, the call will be terminated. This is useful on systems that are silent when the tenant hangs up to assure the **K-1270** disconnects. It is factory set to 10 seconds and can be disabled by entering "**00**" in position 44.

L. Talk/Listen Delay

This time represents the amount of time the **K-1270** will delay before switching back to the microphone mode after it was in the speaker mode (VOX switching time). It is in 100 msec increments and stored in position 45.

M. Dialing Speed

On some phone lines, a faster rate of dialing is allowed. The dialing speed of the **K-1270** can be altered to take advantage of this faster rate. The normal dialing speed is 5 digits per second and is selected by entering "**#30**" (factory setting) while in programming. To increase the speed to 10 digits per second, enter "**#31**". If the faster rate is selected, be sure to test each number to assure proper operation.

N. Hang Up on Return to Dial Tone

The **K-1270** is factory set to hang up if continuous audio is detected after dialing. In most situations this would happen if the tenant hung up and the service that the **K-1270** is connected to provides a dial tone following the hang up. In some instances due to noisy lines or loud background noise, the call may be terminated before the tenant hangs up. If this occurs, enter "**#33**" when in programming. This will disable return to dial tone feature and stop the **K-1270** from hanging up prematurely. To enable this feature enter "**#32**" when in programming.

O. Tenant Initiated Entry

See Operation for a functional description of this feature. Tenant Initiated Entry is disabled by default. To enable it, enter programming (see **Programming** section **A**). Enter **#38**. Also, DIP switch 1 must be turned ON and left in this position to enable the **K-1270** to answer incoming calls. To disable Tenant Initiated Entry, enter **#37**.

Security considerations with Tenant Initiated Entry: The **K-1270** door entry system is designed with security in mind, which is the reason an access code is recommended in cases where Tenant Initiated Entry is allowed. To understand the need for an access code, consider the following example. A person walks up to the entry and pushes one of the directory buttons on the **K-1270**. The unit looks up the number associated with that directory position and dials it. The phone inside the tenant's apartment rings, and is answered by someone who happens to be a guest in the tenant's apartment. The guest notices that the tenant's phone is displaying the caller ID of the number that just called, which is the number of the **K-1270**. They jot the number down. The guest can now call the **K-1270** at a later time, if DIP switch 1 is on, Tenant Initiated Entry is allowed, the access code is disabled, and they know the door strike code, they can let themselves into the building. Note that by default, Tenant Initiated Entry is not allowed, but if this feature is allowed, it is important to program an access code (see **C. Access Code (memory location #48)**).

P. Special Commands

To clear all speed dial positions and set all modes back to factory setting, enter "**###**" while in programming. **Caution**, all previous programming will be lost. Normally when the **K-1270** is in the programming mode, it will hang up the line if no commands are detected for 20 seconds. To hang up immediately, enter "**##7**".

Q. DIP Switch Programming / Speaker and Microphone Adjustments

Two POTs are provided to increase or decrease speaker volume and microphone sensitivity. In certain noisy locations the microphone sensitivity may need to be decreased as shown below. **Caution:** *Setting the microphone gain too high may cause distorted audio, prevent the distant party from breaking over and inhibit second number redialing.*

Switch	Position	Description
1	ON	Incoming calls answered (factory setting)
1	OFF	Incoming calls not answered
2 & 3	ON	Audio Detection normal (factory setting)
2 & 3	OFF	Audio Detection more sensitive
4	ON	Learn Mode - Any incoming calls are automatically entered into the programming mode, no security code required. Use this option if you have forgotten your security code.
4	OFF	Normal operation mode (factory setting)

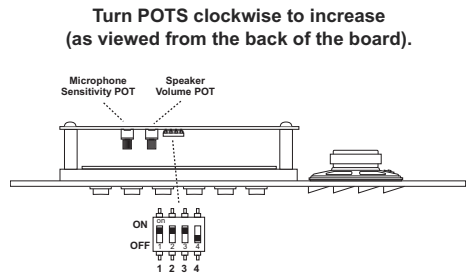

Note: *On some phone lines, busy and ring back tones may be very soft. In these installations, set DIP switches 2 and 3 to OFF.*

Operation

When a visitor is at the **K-1270**, they just need to find the name of the tenant they want to visit on the directory and press the associated button. The **K-1270** will then seize the phone line and speed dial the number programmed for that name. When the tenant answers the call, they can let the visitor in by entering the Door Strike Code on their telephone keypad. The tenant can converse with the visitor for up to 10 seconds after the Door Strike Code is dialed (to verify the visitor has been granted entry). The **K-1270** is able to determine if the door strike command is coming from the apartment or the caller, to prevent entry using a hand held touch tone dialer. If the tenant chooses not to let the visitor in, they can simply hang up the phone. The **K-1270** will drop the line when busy, reorder, CPC signals are detected, when programmable maximum call time out, silence time out, maximum ring timers expire or 10 seconds after a door strike activation. Only the buttons that have a programmed phone number are active (except “#” when used for keyless entry). After a button is pressed, and the call is initiated, it can be canceled by momentarily pressing any button on the panel.

If a second number is programmed for the selected tenant, and there is no answer or busy after dialing the first number, the **K-1270** will hang up, pause, seize the line, and then dial this second number. In this manner the call can be routed to a cell phone if the tenant is not at home. The tenant can still let the visitor in using the Door Strike Code.

It is also possible to talk to a visitor before they press a directory button, and to let them in if Tenant Initiated Entry has been enabled. Make sure DIP switch 1 is on (Auto Answer, see section Q), and then call the number of the K-1270. The unit will answer and send a single or double beep. After a single beep, if Tenant Initiated Entry is not enabled the tenant can converse with the visitor but is not able to use the doorstrike code to let them in. If Tenant Initiated Entry is enabled, the tenant can enter the access code following the single beep, hear two acknowledgement beeps, and then either let the visitor in using the doorstrike code or hang up to terminate the call. A double beep after the unit answers indicates both that Tenant Initiated Entry is enabled and that the access code is disabled, so the user can let the visitor in using the doorstrike code without having to enter the access code, or terminate the call by hanging up.

To use the keyless entry feature, momentarily press or press and hold the “#” key on the **K-1270** keypad. When momentarily pressed, 1 beep will be heard and if held for 2 seconds (or longer), 2 beeps will be heard. In either case, the **K-1270** is then ready to accept the keyless code. Continue by entering one of the previously programmed keyless codes. The **K-1270** will pause a few seconds to make sure there are no more keypad entries, and then actuates the Door Strike relay if valid. If an incorrect code is entered, the **K-1270** will beep 3 times and the user has to start over and enter a correct code.

If a Postal Lock is used, a momentary closure of the postal lock switch will energize the door strike for the programmed Door Strike Time.

Warranty

IF YOU HAVE A PROBLEM WITH A VIKING PRODUCT, CONTACT: VIKING TECHNICAL SUPPORT AT (715) 386-8666

Our Technical Support Department is available for assistance Monday 8am - 4pm and Tuesday through Friday 8am - 5pm central time. So that we can give you better service, before you call please:

1. Know the model number, the serial number and what software version you have (see serial label).
2. Have your Product manual in front of you.
3. It is best if you are on site.

RETURNING PRODUCT FOR REPAIR

The following procedure is for equipment that needs repair:

1. Customer must contact Viking's Technical Support Department at 715-386-8666 to obtain a Return Authorization (RA) number. The customer MUST have a complete description of the problem, with all pertinent information regarding the defect, such as options set, conditions, symptoms, methods to duplicate problem, frequency of failure, etc.
2. Packing: Return equipment in original box or in proper packing so that damage will not occur while in transit. Static sensitive equipment such as a circuit board should be in an anti-static bag, sandwiched between foam and individually boxed. All equipment should be wrapped to avoid packing material lodging in or sticking to the equipment. Include ALL parts of the equipment. C.O.D. or freight collect shipments cannot be accepted. Ship cartons prepaid to: **Viking Electronics, 1531 Industrial Street, Hudson, WI 54016**
3. Return shipping address: Be sure to include your return shipping address inside the box. We cannot ship to a PO Box.
4. RA number on carton: In large printing, write the R.A. number on the outside of each carton being returned.

RETURNING PRODUCT FOR EXCHANGE

The following procedure is for equipment that has failed out-of-box (within 10 days of purchase):

1. Customer must contact Viking's Technical Support at 715-386-8666 to determine possible causes for the problem. The customer MUST be able to step through recommended tests for diagnosis.
2. If the Technical Support Product Specialist determines that the equipment is defective based on the customer's input and troubleshooting, a Return Authorization (R.A.) number will be issued. This number is valid for fourteen (14) calendar days from the date of issue.
3. After obtaining the R.A. number, return the approved equipment to your distributor, referencing the R.A. number. Your distributor will then replace the product over Viking using the same R.A. number.
4. **The distributor will NOT exchange this product without first obtaining the R.A. number from you. If you haven't followed the steps listed in 1, 2 and 3, be aware that you will have to pay a restocking charge.**

TWO YEAR LIMITED WARRANTY

Viking warrants its products to be free from defects in the workmanship or materials, under normal use and service, for a period of two years from the date of purchase from any authorized Viking distributor. If at any time during the warranty period, the product is deemed defective or malfunctions, return the product to Viking Electronics, Inc., 1531 Industrial Street, Hudson, WI., 54016. Customer must contact Viking's Technical Support Department at 715-386-8666 to obtain a Return Authorization (R.A.) number.

This warranty does not cover any damage to the product due to lightning, over voltage, under voltage, accident, misuse, abuse, negligence or any damage caused by use of the product by the purchaser or others. This warranty does not cover non-EWP products that have been exposed to wet or corrosive environments. This warranty does not cover stainless steel surfaces that have not been properly maintained.

NO OTHER WARRANTIES. VIKING MAKES NO WARRANTIES RELATING TO ITS PRODUCTS OTHER THAN AS DESCRIBED ABOVE AND DISCLAIMS ANY EXPRESS OR IMPLIED WARRANTIES OR MERCHANTABILITY OR FITNESS FOR ANY PARTICULAR PURPOSE.

EXCLUSION OF CONSEQUENTIAL DAMAGES. VIKING SHALL NOT, UNDER ANY CIRCUMSTANCES, BE LIABLE TO PURCHASER, OR ANY OTHER PARTY, FOR CONSEQUENTIAL, INCIDENTAL, SPECIAL OR EXEMPLARY DAMAGES ARISING OUT OF OR RELATED TO THE SALE OR USE OF THE PRODUCT SOLD HEREUNDER.

EXCLUSIVE REMEDY AND LIMITATION OF LIABILITY. WHETHER IN AN ACTION BASED ON CONTRACT, TORT (INCLUDING NEGLIGENCE OR STRICT LIABILITY) OR ANY OTHER LEGAL THEORY, ANY LIABILITY OF VIKING SHALL BE LIMITED TO REPAIR OR REPLACEMENT OF THE PRODUCT, OR AT VIKING'S OPTION, REFUND OF THE PURCHASE PRICE AS THE EXCLUSIVE REMEDY AND ANY LIABILITY OF VIKING SHALL BE SO LIMITED.

IT IS EXPRESSLY UNDERSTOOD AND AGREED THAT EACH AND EVERY PROVISION OF THIS AGREEMENT WHICH PROVIDES FOR DISCLAIMER OF WARRANTIES, EXCLUSION OF CONSEQUENTIAL DAMAGES, AND EXCLUSIVE REMEDY AND LIMITATION OF LIABILITY, ARE SEVERABLE FROM ANY OTHER PROVISION AND EACH PROVISION IS A SEPARABLE AND INDEPENDENT ELEMENT OF RISK ALLOCATION AND IS INTENDED TO BE ENFORCED AS SUCH.

FCC REQUIREMENTS

This equipment complies with Part 68 of the FCC rules and the requirements adopted by the ACTA. On the side of this equipment is a label that contains, among other information, a product identifier in the format US:AAAEQ##TXXXX. If requested, this number must be provided to the telephone company.

The REN is used to determine the number of devices that may be connected to a telephone line. Excessive REN's on a telephone line may result in the devices not ringing in response to an incoming call. In most but not all areas, the sum of the REN's should not exceed five (5.0). To be certain of the number of devices that may be connected to a line, as determined by the total REN's, contact the local telephone company. For products approved after July 23, 2001, the REN for this product is part of the product identifier that has the format US:AAAEQ##TXXXX. The digits represented by ## are the REN without a decimal point (e.g., .03 is a REN of 0.3). For earlier products, the REN is separately shown on the label.

The plug used to connect this equipment to the premises wiring and telephone network must comply with the applicable FCC Part 68 rules and requirements adopted by the ACTA. If your home has specially wired alarm equipment connected to the telephone line, ensure the installation of this K-1270/EWP does not disable your alarm equipment. If you have questions about what will disable alarm equipment, consult your telephone company or a qualified installer.

If the K-1270/EWP causes harm to the telephone network, the telephone company will notify you in advance that temporary discontinuance of service may be required. But if advance notice isn't practical, the telephone company will notify the customer as soon as possible. Also, you will be advised of your right to file a complaint with the FCC if you believe it is necessary.

The telephone company may make changes in its facilities, equipment, operations, or procedures that could affect the operation of the equipment. If this happens, the telephone company will provide advance notice in order for you to make the necessary modifications to maintain uninterrupted service.

If trouble is experienced with the K-1270/EWP, for repair or warranty information, please contact: **Viking Electronics, Inc., 1531 Industrial Street, Hudson, WI 54016 (715) 386-8666**

If the equipment is causing harm to the telephone network, the telephone company may request that you disconnect the equipment until the problem is resolved.

Connection to Party Line Service is subject to State Tariffs. Contact the state public utility commission, public service commission or corporation commission for information.

WHEN PROGRAMMING EMERGENCY NUMBERS AND (OR) MAKING TEST CALLS TO EMERGENCY NUMBERS:

Remain on the line and briefly explain to the dispatcher the reason for the call. Perform such activities in the off-peak hours, such as early morning or late evenings.

It is recommended that the customer install an AC surge arrester in the AC outlet to which this device is connected. This is to avoid damaging the equipment caused by local lightning strikes and other electrical surges.

PART 15 LIMITATIONS

This equipment has been tested and found to comply with the limits for a Class A digital device, pursuant to Part 15 of the FCC Rules. These limits are designed to provide reasonable protection against harmful interference when the equipment is operated in a commercial environment. This equipment generates, uses, and can radiate radio frequency energy and, if not installed and used in accordance with the instruction manual, may cause harmful interference to radio communications. Operation of this equipment in a residential area is likely to cause harmful interference in which case the user will be required to correct the interference at his own expense.

Product Support: (715) 386-8666

Due to the dynamic nature of the product design, the information contained in this document is subject to change without notice. Viking Electronics, and its affiliates and/or subsidiaries assume no responsibility for errors and omissions contained in this information. Revisions of this document or new editions of it may be issued to incorporate such changes.