



# TECHNICAL Practice

**TELECOM SOLUTIONS FOR THE 21ST CENTURY**

**E-10, E-15,  
E-20A**

**Speaker Phones**

September 17, 2002

## Provide Convenient Handsfree Communication



**E-10/E-15**

Viking's **DLE-200B** ring down circuit.

The **E-10, E-15** and **E-20A** are line powered speaker phones designed to provide two-way handsfree communication.

The **E-10, E-15** and **E-20A** can be connected directly to a C.O. line or analog PABX/KSU station when used in conjunction with a Hot-Line Dialer or programmed ring down circuit. The **E-10, E-15** and **E-20A** can also be used with



**E-20A**

When the "Call" button is pressed, the **E-10/E-20A** will come off-hook and will remain off-hook until the pre-selected timeout has elapsed. During this time the user may converse handsfree. Alternatively, the **E-15** "Call" button must be pressed and held for the duration of the call.

**Phone... 715.386.8861**

## Features

- Telephone line powered
- Weather resistant
- Adjustable microphone and speaker volume

### E-10/E-20A Features

- Adjustable call time out, to limit prank calls and false alarms (approximately 30 sec - 6 min)
- Auto-answer feature allows remote monitoring (can be disabled)
- Two way handsfree communication

**E-15 Feature** Push and hold to talk button

### E-10/E-15 Features

- Vandal resistant, black powder painted, aluminum face plate with heavy duty metal call button and mounting gasket
- Flush mountable using included plastic rough-in box part # **259576**
- Surface mountable using the **VE-5x5** surface mount box

**?** Need More Information on VE-5x5?  
Call (715) 386-4345 and select 424.

### E-20A Features

- Light gray colored, impact resistant, U.V. stable, plastic chassis
- Surface mountable only

## Applications

- Commercial, industrial and residential door security
- Door or gate communication
- Truck stop/gas station fuel island communication
- Business delivery entrances
- Use in conjunction with a Viking Hot-Line Dialer on C.O. lines or analog PABX/KSU stations
- Use on any programmed ringdown circuit of an analog PABX/KSU station

[info@vikingelectronics.com](mailto:info@vikingelectronics.com)

<http://www.vikingelectronics.com>

## Specifications

**Power:** Telephone line powered (18 VDC/20mA minimum)  
**Dimensions:** **E-10/E-15** - Overall - 127mm x 127mm x 57.2mm (5.0" x 5.0" x 2.25"), Plastic electrical box - 102mm x 102mm x 57mm (4" x 4" x 2.25"), **E-20A** - 140mm x 115mm x 38mm (5.5" x 4.5" x 1.5").  
**Shipping Weights:** **E-10/E-15** - 0.91 kg (2 lbs), **E-20A** - .75 kg (1.5 lbs)  
**Connections:** (1) RJ11 jack or (2) wire nuts

# Installation

## A. Mounting the E-10 and E-15

The **E-10** and **E-15** are designed to be flush mounted to the included 4" x 4" x 2" deep plastic rough in box or surface mounted using optional Viking model **VE-5x5**. **Note: The E-10 and E-15 will NOT mount to a standard double gang box. The plastic rough in box (part # 259576) may be purchased separately in advance. Go to [www.vikingelectronics.com](http://www.vikingelectronics.com) and click on "Spare Parts".**

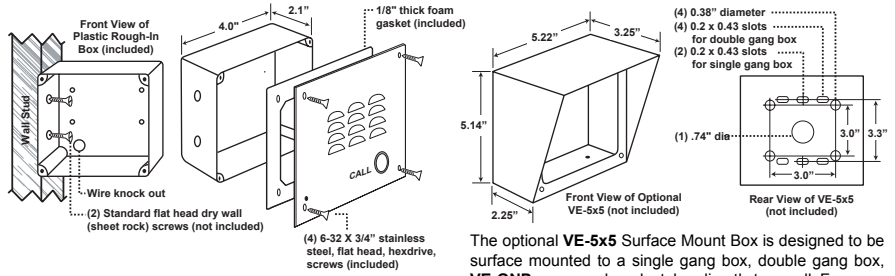

The optional **VE-5x5** Surface Mount Box is designed to be surface mounted to a single gang box, double gang box, **VE-GNP** gooseneck pedestal or directly to a wall. For more information, retrieve **Fax Back Document 424**.

## B. Mounting the E-20A

The **E-20A** is designed to be surface mounted to a single gang box (not included) or a standard 4" x 4" electrical junction box (not included).

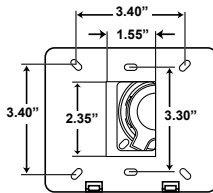

Front view of the E-20A

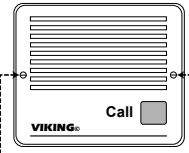

To open the speaker box, remove the two screws from the cover.

Back panel of the E-20A

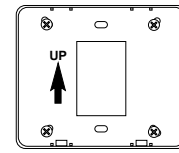

Mount back panel to a wall, a single gang box or a 4"x4" junction box with the arrow pointing up. **Note: For outdoor applications apply a bead of caulk between back panel and wall.**

Side view of the E-20A

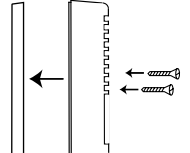

Attach the cover to the base with the two included screws as shown.

## C. Wiring

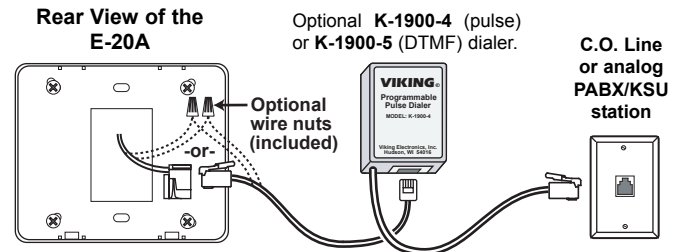
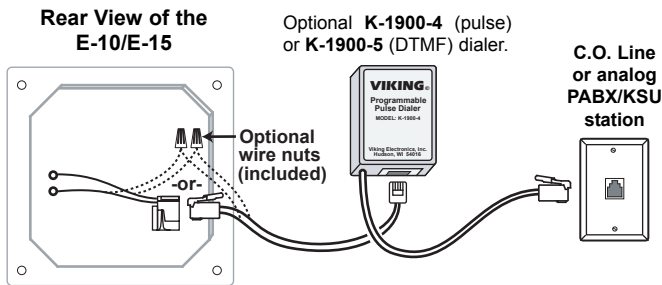

**Notes:** Talk battery must be a minimum of 28V DC when using an **E-10**, **E-15** or **E-20A** with a Hot-Line Dialer. For more information on Hot-Line Dialers, retrieve **Fax Back Documents 833**.

# Programming

## A. Changing the Call Time-Out

The **E-10** and **E-20A** are equipped with an adjustable call time-out feature which automatically hangs-up the **E-10** or **E-20A** after the pre-set time has elapsed. To change the time-out, adjust the call time as shown to the right. The time can be adjusted from approximately 30 seconds to 6 minutes (factory set to approximately 3 minutes).

## B. Adjusting Speaker Volume

The **SPKR VOL** pot can be adjusted to increase or decrease the speaker volume to the level desired as shown to the right.

## C. Adjusting the Microphone Volume

In certain noisy locations (background traffic, machinery or wind), the microphone volume may need to be decreased. A symptom of this is one-way talk path, in which the distant party cannot be heard over the speaker. A **MIC ADJ** pot is provided on the **E-10**, **E-15** and **E-20A** for increasing or decreasing the microphone sensitivity. **Note: If the microphone volume is set too high or too low, one-way talk path may occur.**

## D. Disabling the Auto-Answer feature

The **E-10** and **E-20A** come factory set to auto answer when an inbound call is detected. To disable this feature, cut the resistor shown through the hole on the back of the circuit board as shown to the right. **Important: Disconnect the telephone line before cutting the auto-answer resistor.**

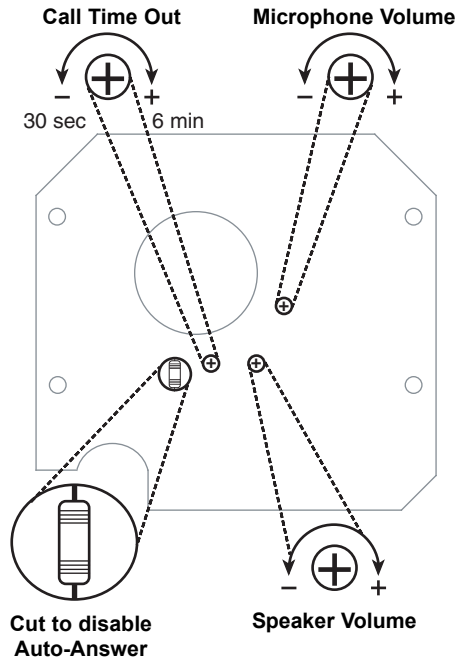

**Product Support Line...715.386.8666**

**Fax Back Line...715.386.4345**

Due to the dynamic nature of the product design, the information contained in this document is subject to change without notice. Viking Electronics, and its affiliates and/or subsidiaries assume no responsibility for errors and omissions contained in this information. Revisions of this document or new editions of it may be issued to incorporate such changes.