



# TECHNICAL Practice

**TELECOM SOLUTIONS FOR THE 21ST CENTURY**

**PF-6A**

**Power Fail Bypass or  
Ground to Loop  
Start Converter**

April 21, 2009

## Power Failure Bypass System



The **PF-6A** power failure bypass system makes it possible to receive calls during phone system and power outages. The **PF-6A** bypass unit connects 6 pre-assigned single line station phones directly to user-assigned C.O. trunks. A built-in ground start converter permits outbound calls from standard phones.

When the system is restored, calls in progress are not lost. The **PF-6A** bypass unit will reconnect phones to their station circuits after they become idle.

The **PF-6A** can be configured to operate when power is lost or from an opening/closing of an alarm contact or manual closure.

Alternatively, the **PF-6A** can be used to convert six incoming ground start lines to loop start lines. This accommodates installation of telephony equipment requiring loop start lines (example: key systems, call sequencers, answering machines, voice mail, etc.)

*Phone...715.386.8861*

## Features

- Transfers six C.O. trunks directly to the designated analog station phones
- Stackable to increase capacity
- Allows user to receive calls, as well as make calls during power or system failure
- Compatible with loop start lines or 48V ground start lines
- Automatic ground start converter eliminates "ground start buttons"
- Power restoration will not interrupt calls in progress
- Operates on power failure or normally open - normally closed alarm contacts

## Applications

- Prevents busy signals or unanswered calls during power and system failures
- Converts ground start lines to standard loop start lines

*Made in the U.S.A.*

*[www.vikingelectronics.com](http://www.vikingelectronics.com)*

*[info@vikingelectronics.com](mailto:info@vikingelectronics.com)*

## Specifications

**Power:** 120 V AC/13.8V AC 1.25A, UL listed adapter provided or 24-48V DC, 100mA

**Dimensions:** 211mm x 160mm x 46mm (8.3" x 6.5" x 1.8")

**Shipping Weight:** 1.2 kg (2.6 lbs)

**Environmental:** 0°C to 32°C (32°F to 90°F) with 5% to 95% non-condensing humidity

**Connections:** (1) RJ21X, (1) RJ11

## IF YOU HAVE A PROBLEM WITH A VIKING PRODUCT, PLEASE CONTACT: VIKING TECHNICAL SUPPORT AT (715) 386-8666

Our Technical Support Department is available for assistance weekdays between 8 a.m. and 5 p.m. central time. So that we can give you better service, before you call please:

1. Know the model number, the serial number and what software version you have (see serial label).
2. Have your Technical Practice in front of you.
3. It is best if you are on site.

### RETURNING PRODUCT FOR REPAIR

The following procedure is for equipment that needs repair:

1. Customer must contact Viking's Technical Support Department at 715-386-8666 to obtain a Return Authorization (RA) number. The customer MUST have a complete description of the problem, with all pertinent information regarding the defect, such as options set, conditions, symptoms, methods to duplicate problem, frequency of failure, etc.
2. Packing: Return equipment in original box or in proper packing so that damage will not occur while in transit. Static sensitive equipment such as a circuit board should be in an anti-static bag, sandwiched between foam and individually boxed. All equipment should be wrapped to avoid packing material lodging in or sticking to the equipment. Include ALL parts of the equipment. C.O.D. or freight collect shipments cannot be accepted. Ship cartons prepaid to:  
**Viking Electronics, 1531 Industrial Street, Hudson, WI 54016**
3. Return shipping address: Be sure to include your return shipping address inside the box. We cannot ship to a PO Box.
4. RA number on carton: In large printing, write the R.A. number on the outside of each carton being returned.

### RETURNING PRODUCT FOR EXCHANGE

The following procedure is for equipment that has failed out-of-box (within 10 days of purchase):

1. Customer must contact Viking's Technical Support at 715-386-8666 to determine possible causes for the problem. The customer **MUST** be able to step through recommended tests for diagnosis.
2. If the Technical Support Product Specialist determines that the equipment is defective based on the customer's input and troubleshooting, a Return Authorization (R.A.) number will be issued. This number is valid for fourteen (14) calendar days from the date of issue.
3. After obtaining the R.A. number, return the approved equipment to your distributor, referencing the R.A. number. Your distributor will then replace the product over the counter at no charge. The distributor will then return the product to Viking using the same R.A. number.
4. **The distributor will NOT exchange this product without first obtaining the R.A. number from you. If you haven't followed the steps listed in 1, 2 and 3, be aware that you will have to pay a restocking charge.**

### WARRANTY

Viking warrants its products to be free from defects in the workmanship or materials, under normal use and service, for a period of one year from the date of purchase from any authorized Viking distributor or 18 months from the date manufactured, whichever ever is greater. If at any time during the warranty period, the product is deemed defective or malfunctions, return the product to Viking Electronics, Inc., 1531 Industrial Street, Hudson, WI, 54016. Customer must contact Viking's Technical Support Department at 715-386-8666 to obtain a Return Authorization (R.A.) number.

This warranty does not cover any damage to the product due to lightning, over voltage, under voltage, accident, misuse, abuse, negligence or any damage caused by use of the product by the purchaser or others.

Viking's sole responsibility shall be to repair or replace (at Viking's option) the material within the terms stated above. VIKING SHALL NOT BE LIABLE FOR ANY LOSS OR DAMAGE OF ANY KIND INCLUDING INCIDENTAL OR CONSEQUENTIAL DAMAGES RESULTING DIRECTLY OR INDIRECTLY FROM ANY BREACH OF ANY WARRANTY EXPRESSED OR IMPLIED, OR FOR ANY OTHER FAILURE OF THIS PRODUCT. Some states do not allow the exclusion or limitation of incidental or consequential damages, so this limitation may not apply to you.

THIS WARRANTY IS IN LIEU OF ALL OTHER WARRANTIES, EXPRESSED OR IMPLIED, INCLUDING THE WARRANTIES OF MERCHANTABILITY AND FITNESS FOR A PARTICULAR PURPOSE, WHICH ARE HEREBY EXCLUDED BEYOND THE ONE YEAR DURATION OF THIS WARRANTY. Some states do not allow limitation on how long an implied warranty lasts, so the above limitation may not apply to you.

### FCC REQUIREMENTS

This equipment complies with Part 68 of the FCC rules. Located on the equipment is a label that contains, among other information, the FCC registration number and ringer equivalence number (REN). If requested, this information must be provided to the telephone company.

The REN is used to determine the quantity of devices which may be connected to the telephone line. Excessive REN's on the telephone line may result in the devices not ringing in response to an incoming call. In most, but not all areas, the sum of the REN's should not exceed five (5.0). To be certain of the number of devices that may be connected to the line, as determined by the total REN's, contact the telephone company to determine the maximum REN for the calling area.

This equipment cannot be used on the telephone company-provided coin service. Connection to Party Line Service is subject to State Tariffs.

If this equipment causes harm to the telephone network, the telephone company will notify you in advance that temporary discontinuance of service may be required. If advance notice isn't practical, the telephone company will notify the customer as soon as possible. Also, you will be advised of your right to file a complaint with the FCC if you believe it is necessary.

The telephone company may make changes in its facilities, equipment, operations, or procedures that could affect the operation of the equipment. If this happens, the telephone company will provide advance notice in order for you to make the necessary modifications in order to maintain uninterrupted service.

If trouble is experienced with this equipment, please contact: **Viking Electronics, Inc., 1531 Industrial Street, Hudson, WI 54016 (715) 386-8666**

If the trouble is causing harm to the telephone network, the telephone company may request you to remove the equipment from the network until the problem is resolved.

The PF-6A uses the USOC jack RJ21X.

It is recommended that the customer install an AC surge arrester in the AC outlet to which this device is connected. This is to avoid damaging the equipment caused by local lightning strikes and other electrical surges.

This equipment is Hearing-Aid Compatible (HAC).

The telephone Consumer Protection Act of 1991 makes it unlawful for any person to use a computer or other electronic device, including fax machines, to send any message unless such message clearly contains in a margin at the top or bottom of each transmitted page or on the first page of the transmission, the date and time it is sent and an identification of the business or other entity, or other individual sending the message and the telephone number of the sending machine or such business, other entity, or individual. (The telephone number provided may not be a 900 number or any other number for which charges exceed local or long-distance transmission charges.)

### PART 15 LIMITATIONS

This equipment has been tested and found to comply with the limits for a Class A digital device, pursuant to Part 15 of the FCC Rules. These limits are designed to provide reasonable protection against harmful interference when the equipment is operated in a commercial environment. This equipment generates, uses, and can radiate radio frequency energy and, if not installed and used in accordance with the instruction manual, may cause harmful interference to radio communications. Operation of this equipment in a residential area is likely to cause harmful interference in which case the user will be required to correct the interference at his own expense.

# Installation

**Note:** The unit can also be powered by 24-48V DC PABX battery supply on terminals 50 & 25.

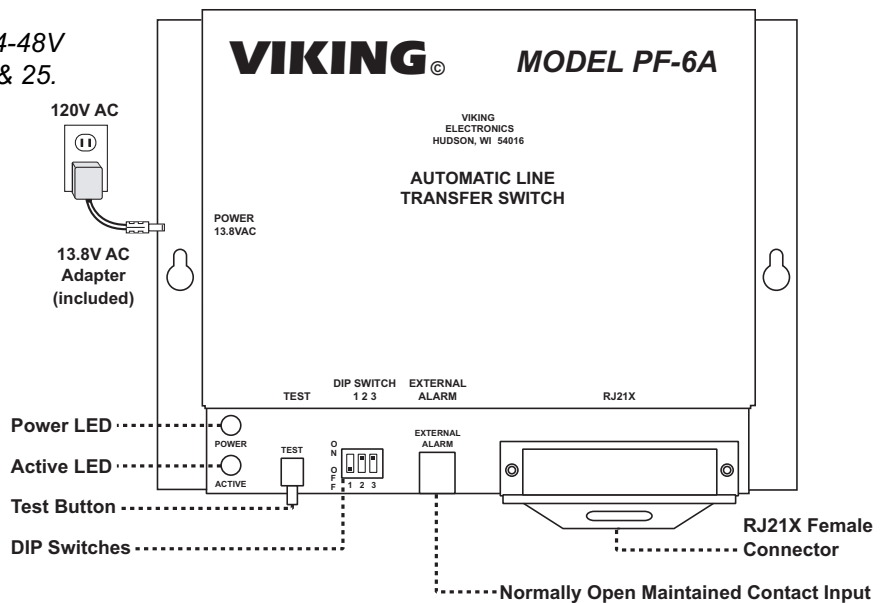

The Power LED and Active LED will be lit when the PF-6A is in the normal operating mode. The Active LED will go out and the Power LED will stay lit when the Test Button is pressed.

**IMPORTANT:** Electronic devices are susceptible to lightning and power station electrical surges from both the AC outlet and the telephone line. It is recommended that a surge protector be installed to protect against such surges. Contact Panamax at (800) 472-5555 or Electronic Specialists Inc. at (800) 225-4876.

## A. Power Fail Bypass Unit

The first six C.O. lines should be interfaced with the **PF-6A** as shown in the chart to the right. The **PF-6A** is sensitive to the polarity of the incoming telephone lines, even when using loop start lines. There is a feature in the **PF-6A** that keeps a "power fail" call from getting interrupted when power is restored (power restoration will not interrupt calls in progress). With loop (or ground) start lines, if the C.O. dial tone coming in is connected in the wrong polarity, this feature will not work. When wired in reverse polarity and power is restored, a call in progress is dropped immediately.

If your system has an alarm contact or manual transfer switch, you must connect it to the red and green wires of the modular jack labeled **EXTERNAL ALARM** on **PF-6A**. This must be a normally open maintained contact closure. If normally closed alarm contacts are used, wire them to break the power to the **PF-6A** when they open.

**Note:** Loop start and ground start CO lines may be combined on the **PF-6A** (see **Programming**). When ground start lines are used, pin 50 (V/S) must be connected to a good earth ground.

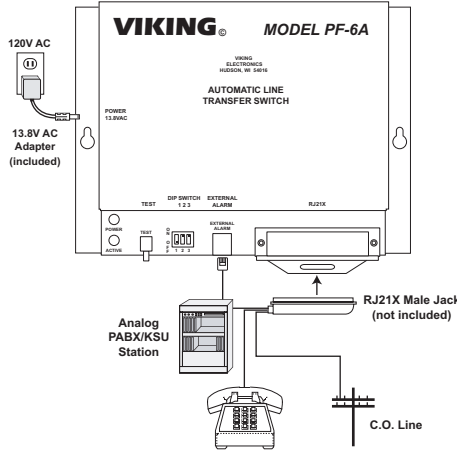

Circuit	Trunk/Station	Line	Pins	Color
Circuit 1	Trunk 1 - IN	T1T-IN T1R-IN	26 1	W/BL BL/W
	Trunk 1 - OUT	T1T-OUT T1R-OUT	27 2	W/O O/W
	Station 1 - IN	S1T-IN S1R-IN	28 3	W/G G/W
	Station 1 - OUT	S1T-OUT S1R-OUT	29 4	W/BN BN/W
Circuit 2	Trunk 2 - IN	T2T-IN T2R-IN	30 5	W/S S/W
	Trunk 2 - OUT	T2T-OUT T2R-OUT	31 6	R/BL BL/R
	Station 2 - IN	S2T-IN S2R-IN	32 7	R/O O/R
	Station 2 - OUT	S2T-OUT S2R-OUT	33 8	R/G G/R
Circuit 3	Trunk 3 - IN	T3T-IN T3R-IN	34 9	R/BN BN/R
	Trunk 3 - OUT	T3T-OUT T3R-OUT	35 10	R/S S/R
	Station 3 - IN	S3T-IN S3R-IN	36 11	BK/BL BL/BK
	Station 3 - OUT	S3T-OUT S3R-OUT	37 12	BK/O O/BK
Circuit 4	Trunk 4 - IN	T4T-IN T4R-IN	38 13	BK/G G/BK
	Trunk 4 - OUT	T4T-OUT T4R-OUT	39 14	BK/BN BN/BK
	Station 4 - IN	S4T-IN S4R-IN	40 15	BK/S S/BK
	Station 4 - OUT	S4T-OUT S4R-OUT	41 16	Y/BL BL/Y
Circuit 5	Trunk 5 - IN	T5T-IN T5R-IN	42 17	Y/O O/Y
	Trunk 5 - OUT	T5T-OUT T5R-OUT	43 18	Y/GN GN/Y
	Station 5 - IN	S5T-IN S5R-IN	44 19	Y/BN BN/Y
	Station 5 - OUT	S5T-OUT S5R-OUT	45 20	Y/S S/Y
Circuit 6	Trunk 6 - IN	T6T-IN T6R-IN	46 21	V/BL BL/V
	Trunk 6 - OUT	T6T-OUT T6R-OUT	47 22	V/O O/V
	Station 6 - IN	S6T-IN S6R-IN	48 23	V/GN GN/V
	Station 6 - OUT	S6T-OUT S6R-OUT	49 24	V/BN BN/V

Station or Trunk Control Line	GND	50	V/S
	-24/48V	25	S/V

PF-6A in Normal Operating Mode (typical for 6 lines)

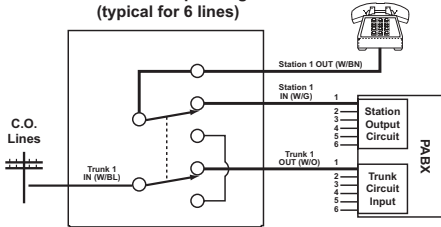

PF-6A in Bypass Mode (typical for 6 lines)

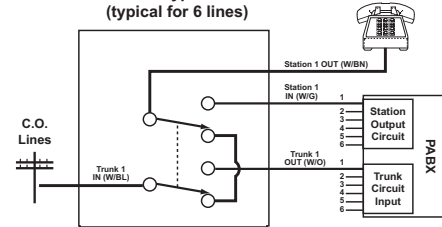

## B. Ground to Loop Start Converter

The ground start converter in the **PF-6A** will only work properly when connected in series with the ground start trunks as shown.

**Important:** Do **NOT** connect the power adapter when using the **PF-6A** in the Ground to Loop Start application.

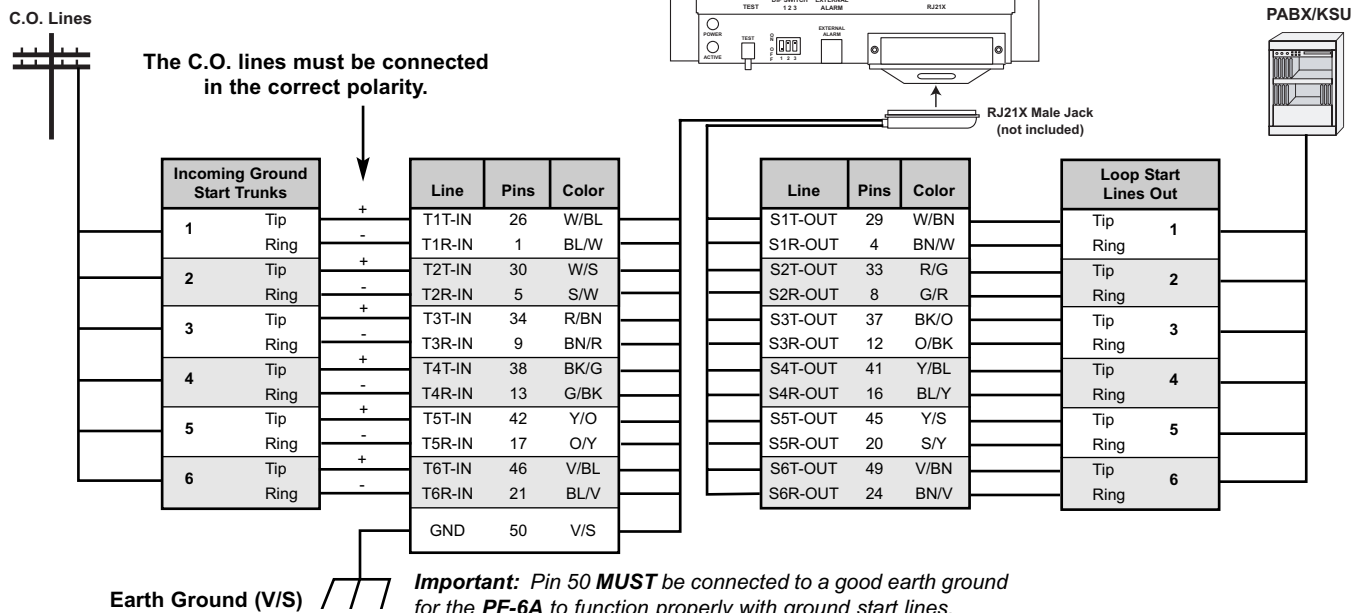

# Programming

DIP Switch	Position	Description
1	OFF	Normal operation
1	ON	Bypass mode for testing
2	OFF	Assigns lines 1, 2, 3 to loop start
2	ON	Assigns lines 1, 2, 3 to ground start
3	OFF	Assigns lines 4, 5, 6 to loop start
3	ON	Assigns lines 4, 5, 6 to ground start

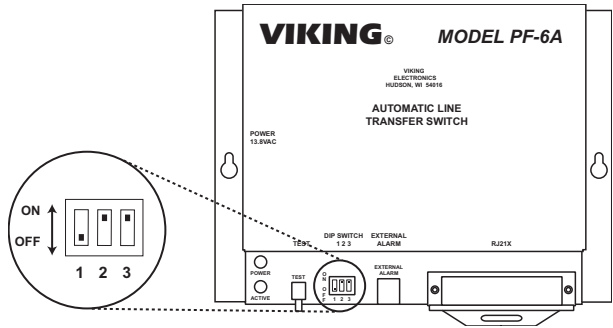

# Operation

## A. Power Fail Bypass Unit

After installation is complete, test the **PF-6A** by doing ONE of the following:

1. Press and hold the **TEST** button
2. Move DIP switch 1 to the ON position
3. Disconnect power to the **PF-6A**
4. Provide a maintained normally open contact closure to the **EXTERNAL ALARM** input

After installing and testing the **PF-6A**, instruct office personnel that in the event of the power failure or system failure that the six assigned telephones will be the only means to receive and place calls.

While the **PF-6A** is in normal operating mode, the six C.O. lines are connected to the trunk inputs, and the six assigned station circuits are connected to their six telephones. In the event of either a power failure or a major PABX alarm, the **PF-6A** will shift into the bypass mode. In this mode, the six C.O. trunks are instantly connected to the six analog telephones designated, bypassing the PABX/KSU. Incoming calls will now ring directly to the telephones assigned to the six C.O. trunks. Outgoing calls may also be made from each telephone, even on ground start lines.

When power is restored or the major alarm is cleared, the **PF-6A** will automatically switch back to normal operation. Any C.O. trunk in use at this time will remain connected until the call is completed.

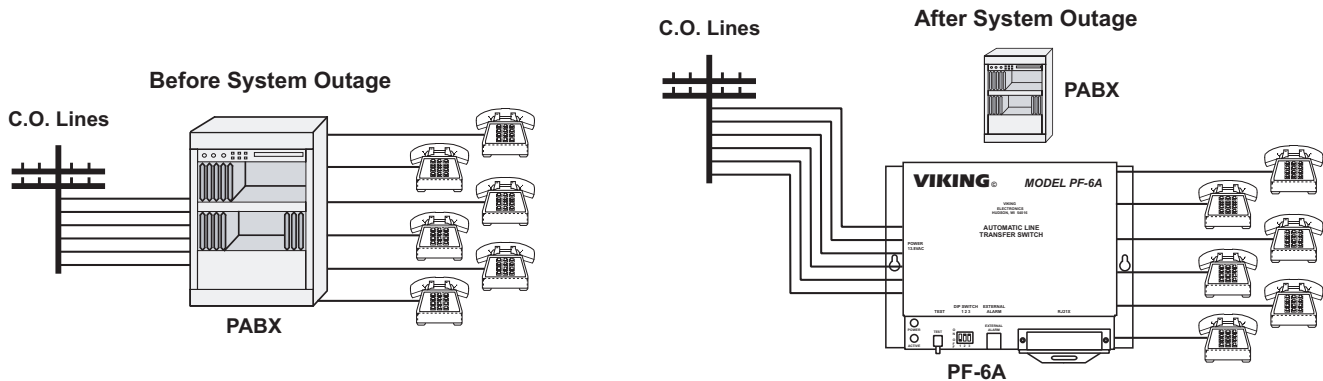

## B. Ground to Loop Start Converter

The **PF-6A** can also be used as a ground start to loop start converter. This accommodates the installation of telephony equipment requiring loop start lines (ie; key systems, call sequencers, answering machines, voice mail systems, etc.), to ground start C.O. trunks. See Installation for proper wiring in this application.

In this application, the **PF-6A** will not pass disconnect supervision ("hang up" signals) to the loop start equipment. When a hang up occurs, the **PF-6A**'s ground start converter automatically "restarts" the line and dial tone is returned to the loop start equipment. The loop start equipment will not detect any disconnect, as this "restart" occurs immediately after the hang up. Typically this will cause the loop start equipment to not release the telephone line when a caller abandons. Nothing can be done about this situation, as the **PF-6A** can not distinguish the difference between this abandon condition and the loop start equipment going "off hook" to make an outgoing call.

**Note:** The **PF-6A** can **ONLY** be used to convert ground start lines to loop start. It can **NOT** convert loop start lines to ground start.

Product Support Line...715.386.8666

Fax Back Line...715.386.4345

Due to the dynamic nature of the product design, the information contained in this document is subject to change without notice. Viking Electronics, and its affiliates and/or subsidiaries assume no responsibility for errors and omissions contained in this information. Revisions of this document or new editions of it may be issued to incorporate such changes.