

## Add Time Controlled Alert Tones and Emergency Tones to Your Paging System

Viking's model **CTG-1A** is a clock controlled tone generator designed to provide accurately timed bong alert tones or buzzer alert tone sounds over an existing paging system.

The **CTG-1A** can be programmed to output single, double or triple alert tones with up to 128 events in a 24 hour period in two separate schedules. These bong / buzzer sounds are ideal for indicating the start and end of shifts, break times, lunch periods, etc. for factories, schools, or any business requiring an audible indication of specified times. Each day of the week can be programmed to either on or off, allowing you to turn off the alert tones during specific days of the week (weekends, etc.) In place of sending tones, the **CTG-1A** can operate in the Timed Relay Mode



to turn on or off the relay at certain times of the day. The **CTG-1A** has three contact closure inputs for triggering an emergency siren, evacuation signal or a doorbell sound.

### Features

- Accurate 24 hour digital time clock displays hours and minutes synced to AC power
- User programmable 24 hour, 128 event timer in **two separate manually selected schedules**
- Programmable day of week on/off feature
- Programmable single, double or triple alert tone output (selectable bong or buzzer)
- Three contact closure controlled sounds:
  - 1) Emergency siren (yelp) sound
  - 2) Temporal (slow whoop) evacuation signal
    - \*NFPA/ANSI compliant when used with supporting equipment
  - 3) Doorbell (chime) sound
- Volume controllable, 600 Ohm line level audio output
- Non-volatile memory with **four day clock backup**
- Two sets of DPDT relay contacts for muting paging or background music during alert tones or timed relay events
- Switchable 50 / 60 Hz operation
- **Switch for Daylight Saving Time**
- **Timed Relay Mode**

### Applications

- Signal the beginning and end of class periods, breaks, and lunch periods for schools
- Signal the beginning and end of shifts, breaks, and lunch periods for factories and other businesses
- Provides a doorbell and / or alarm sounds over an existing paging system, for such applications as door entry, fire, severe weather, etc.
- Use with Viking's **DVA-2WA** to provide timed messages (**DOD 110**)
- Timed relay controller used with Viking's **C-250** and **C-500** controllers to automatically forward entry calls at certain times of the day

### Specifications

- Power:** 120V AC / 13.8V AC 1.25A UL listed adapter provided
- Dimensions:** 5.25" x 3.6" x 1.75" (133mm x 91mm x 44mm)
- Weight:** 2 lbs (0.9 Kg)
- Operating Temperature:** 32°F to 90°F (0°C to 32°C)
- Humidity:** 5% to 95% non-condensing
- Connections:** 12 position cage clamp terminal strip
- Internal Clock Backup Time:** 4 days
- Time Base:** 50/60Hz AC power line
- Time Base Backup Accuracy:** +/- 5 ppm
- Audio Output:** 600 Ohm with volume adjust potentiometer, maximum level = 17 dBm / 5.4Vrms across 600 Ohm load
- Relay Output:** DPDT rated 30V DC @ 1A, 110V DC @ 0.3A, 125V AC @ 0.5A (resistive loads)

# Features Overview

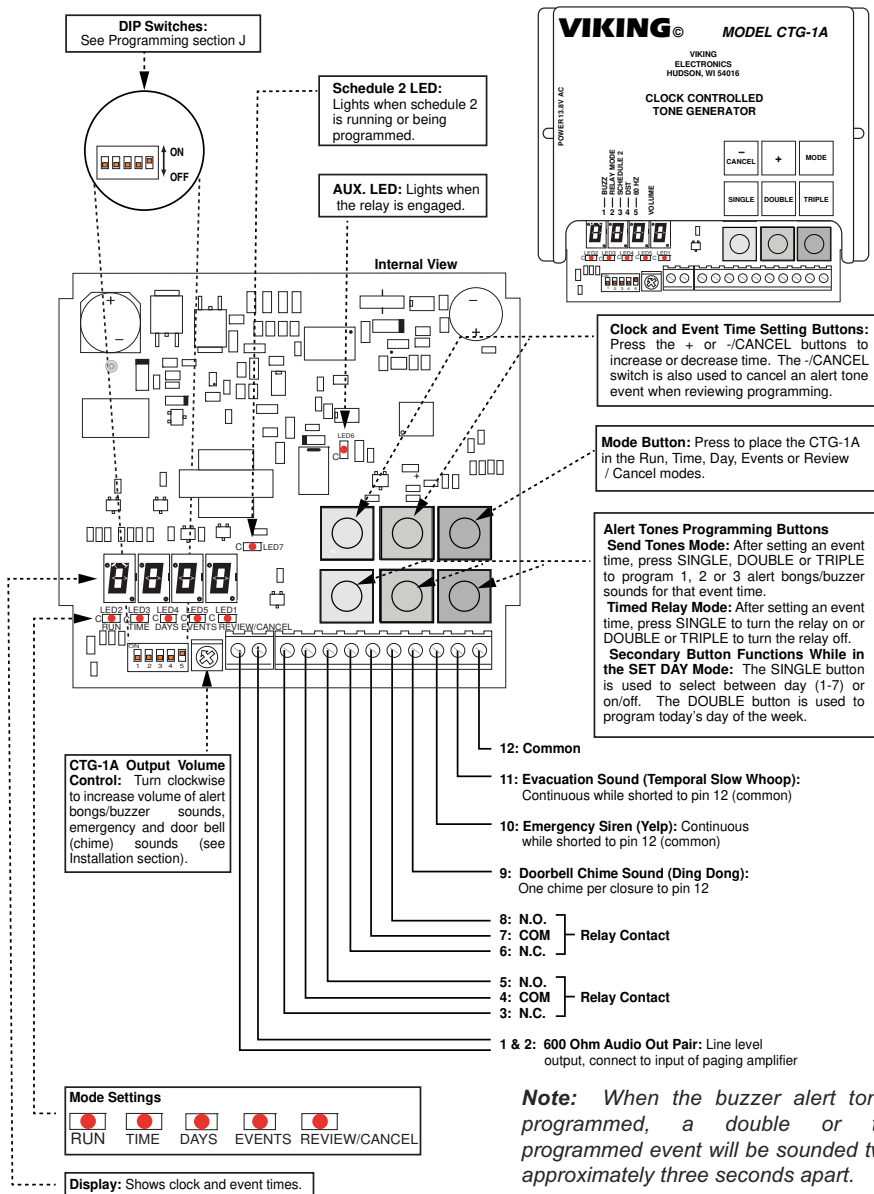

**Note:** When the buzzer alert tone is programmed, a double or triple programmed event will be sounded twice, approximately three seconds apart.

## Installation

Connect the **CTG-1A** between your phone system and your paging amplifier as shown in the diagram below.

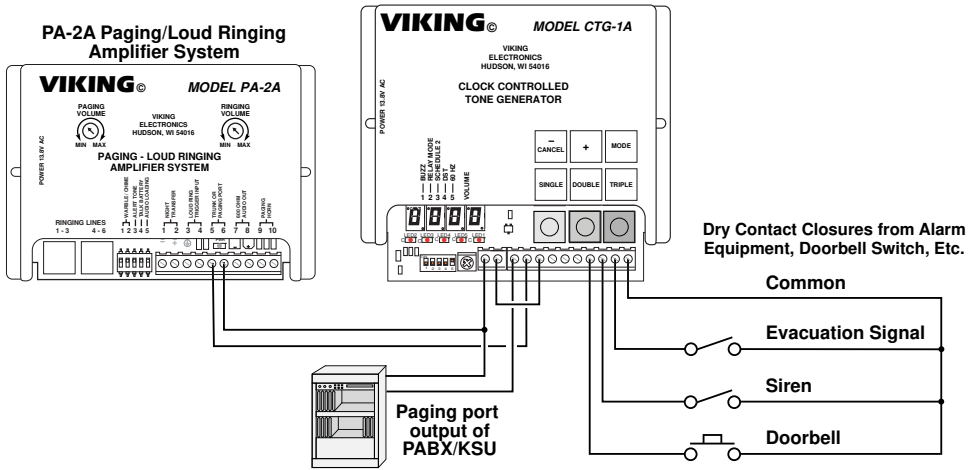

## Programming

### A. Setting the Clock Time

<b>Step 1.</b>	Press the <b>MODE</b> button repeatedly until the <b>TIME</b> indicator lights.
<b>Step 2.</b>	Increase or decrease the clock time by pressing the <b>+</b> or <b>-/CANCEL</b> button until the desired time is displayed. Press and hold the <b>+</b> or <b>-/CANCEL</b> button to speed up the selection.
<b>Step 3.</b>	Leave the set time mode by pressing the <b>MODE</b> button.

**Notes:** See *Programming section O, Daylight Savings Time* for the correct setting of dip switch 4 for the current time of year. If the clock time has been adjusted using the **+** or **-/CANCEL** buttons, the clock will then start to run the moment you leave the time mode, allowing you to synchronize the **CTG-1A** with your building clocks.

### B. Setting the Day of the Week

**Note:** Steps B and C are only required if you want to turn off the Alert Tones on certain days of the week.

<b>Step 1.</b>	Press the <b>MODE</b> button repeatedly until the <b>DAYS</b> indicator lights.
<b>Step 2.</b>	A flashing "A" (without "on" or "of" displayed) indicates today's day has not been set (or power was lost for more than 4 days). The day of week has already been set if a flashing "A" plus "on", flashing "A" plus "of" or flashing number (1-7) plus "on" or "of" are displayed.
<b>Step 3.</b>	Select today's day of the week using the <b>TIME (+ and -/CANCEL)</b> buttons. As a general rule, Sunday is day 1 and Saturday is day 7. When today's day of the week is flashing on the display, set it by pressing the <b>DOUBLE</b> alert tone button. A confirmation beep will be heard and today's day number and "on" or "of" will now be displayed.

**Note:** The day of week setting is a one set up and does not need to be reset unless you experience a power failure longer than backup time of 4 days. To reset the day of week, repeat steps 1 – 3 in section B.

## C. Turning the Alert Tones On/Off for Specific Days of the Week

<b>Step 1.</b>	Press the <b>MODE</b> button repeatedly until the <b>DAYS</b> indicator lights. Flashing “ <b>A</b> ” or the current day of the week and “ <b>on</b> ” or “ <b>of</b> ” will be displayed. “ <b>on</b> ” = alert tones are ON and “ <b>of</b> ” = alert tones are OFF for that day of the week. “ <b>A</b> ” plus “ <b>on</b> ” or “ <b>of</b> ” is every day is ON or OFF.
<b>Step 2.</b>	Set dip switch 3 to off to program specific days to on or off in schedule 1.
<b>Step 3.</b>	With the day of the week flashing, use the <b>TIME (+ and -/CANCEL)</b> buttons to select the day of the week you would like to set to ON or OFF. When the correct day of the week is displayed, press the <b>SINGLE</b> button to flash “ <b>on</b> ” or “ <b>of</b> ”. The day can then be set to ON or OFF by using the <b>TIME (+ and -/CANCEL)</b> buttons. Pressing the <b>SINGLE</b> button will toggle between flashing the day of the week or flashing “ <b>on</b> ” or “ <b>of</b> ”. The flashing portion of the display is the section that can be changed. When rotating through the days of the week, an “ <b>A</b> ” will be displayed between days 1 and 7. This “ <b>A</b> ” selection allows an easy method to set all days of the week to on or off. When set to “ <b>A nC</b> ”, the selections for each day of the week will remain unchanged. Changing the selection to “ <b>A on</b> ” sets all days to <b>ON</b> or “ <b>A oF</b> ” sets all days to <b>OFF</b> .
<b>Step 4.</b>	Review your day of the week programming by pressing the <b>SINGLE</b> button until the weekday (1-7) is flashing, then increment through each day of the week with the <b>TIME (+)</b> button and monitor each day for its on or off setting.
<b>Step 5.</b>	If you need to program specific days to on or off in schedule 2, set dip switch 3 to on and repeat steps 3 and 4.
<b>Step 6.</b>	Exit the <b>DAYS</b> mode by simply pressing the <b>MODE</b> button.

**Notes:** Each schedule has separate day of week programming. Alert tone on/off programming is stored in non-volatile memory, so is never lost with a power failure.

## D. Setting Timed Alert Tones (Dip Switch 2 OFF)

<b>Step 1.</b>	Press the <b>MODE</b> button repeatedly until the <b>EVENTS</b> indicator lights.
<b>Step 2.</b>	Set dip switch 3 to off to program Timed Alert Tones in schedule 1.
<b>Step 3.</b>	Increase or decrease the event time by pressing the <b>TIME (+ or -/CANCEL)</b> button until the desired time is shown. Press and hold the <b>+</b> or <b>-/CANCEL</b> button to speed up the selection.
<b>Step 4.</b>	Move DIP switch 1 to <b>OFF</b> for bong alert tones or <b>ON</b> for buzzer alert tones (see <b>Programming</b> section J).
<b>Step 5.</b>	Press one of the single, double, or triple <b>ALERT TONES</b> buttons to program the number of alert tones you wish to output at the specific event time. A single, double, or triple length confirmation beep should be heard.
<b>Step 6.</b>	Repeat steps 3 - 5 for the remainder of your scheduled events in that schedule.
<b>Step 7.</b>	If you need to program Timed Alert Tones in schedule 2, set dip switch 3 to on and repeat steps 3 through 6.

**Note:** If more than 128 events have been entered in either schedule, a long beep will be heard indicating that the event memory is full.

## E. Reviewing and/or Cancelling Timed Alert Tones (Dip Switch 2 OFF)

<b>Step 1.</b>	Press the <b>MODE</b> button repeatedly until the <b>REVIEW/CANCEL</b> indicator lights.
<b>Step 2.</b>	Set dip switch 3 to off to review and/or cancel events in schedule 1
<b>Step 3.</b>	Press one of the <b>ALERT TONES</b> buttons (single, double, or triple) repeatedly to rotate through the event times associated with that alert tone button. A red LED at the bottom right corner of the time display will light to indicate a buzzer event time (versus a bong event). <i>The <b>CTG-1A</b> will indicate the end of the programmed events for that <b>ALERT TONE</b> button by displaying three dashes (- - -) before it returns to the first programmed event. <b>Note:</b> Event times are stored in the order of programming, not chronologically.</i>
<b>Step 4.</b>	Press the <b>-/CANCEL</b> button to permanently cancel an event tone. A single acknowledgement tone will be heard. The next consecutive event for that specific alert tone will then be displayed.
<b>Step 5.</b>	Repeat steps 3 - 5 as needed to remove the events to be cancelled in that schedule.
<b>Step 6.</b>	If you need to review and/or cancel events in schedule 2, set dip switch 3 to on and repeat steps 3 through 5.

## F. Setting Timed Relay Times (Dip Switch 2 ON)

<b>Step 1.</b>	Press the <b>MODE</b> button repeatedly until the <b>EVENTS</b> indicator lights.
<b>Step 2.</b>	Set dip switch 3 to off to program relay times in schedule 1.
<b>Step 3.</b>	Increase or decrease the event time by pressing the <b>TIME (+ or -/CANCEL)</b> button until the desired time is shown for a relay on or off event. Press and hold the + or <b>-/CANCEL</b> to speed up the selection.
<b>Step 4.</b>	Press the single <b>ALERT TONE</b> button if the displayed time is a relay on event time or the double or triple <b>ALERT TONE</b> buttons if the displayed time is a relay off event time.
<b>Step 5.</b>	Repeat steps 3 and 4 for the remainder of your scheduled relay events in that schedule.
<b>Step 6.</b>	If you need to program timed relay events in schedule 2, set dip switch 3 to on and repeat steps 3 through 5.

## G. Reviewing and/or Cancelling Timed Relay Times (Dip Switch 2 ON)

<b>Step 1.</b>	Press the <b>MODE</b> button repeatedly until the <b>REVIEW/CANCEL</b> indicator lights.
<b>Step 2.</b>	Set dip switch 3 to off to review and/or cancel events in schedule 1.
<b>Step 3.</b>	Press the single <b>ALERT TONE</b> button repeatedly to rotate through the relay on event times. Press the double or triple <b>ALERT TONE</b> buttons repeatedly to rotate through the relay off event times. <i>The <b>CTG-1A</b> will indicate the end of the programmed events for that <b>ALERT TONE</b> button by displaying three dashes (- - -) before it returns to the first programmed event. <b>Note:</b> Event times are stored in the order of programming, not chronologically.</i>
<b>Step 4.</b>	Press the <b>-/CANCEL</b> button to permanently cancel a relay event time. A single acknowledgement tone will be heard. The next consecutive relay on or off event for that alert tone button will then be displayed.
<b>Step 5.</b>	Repeat steps 3 and 4 as needed to remove any other relay on or off events in that schedule.
<b>Step 6.</b>	If you need to review and/or cancel relay on or off events in schedule 2, set dip switch 3 to on and repeat steps 3 through 5.

## H. Adjusting Output Volume

<b>Step 1.</b>	Use a jumper wire to short pins <b>10</b> and <b>12</b> together. The siren sound will then play.
<b>Step 2.</b>	Adjust the output volume control (see <b>Features Overview</b> ) until the desired volume is achieved.
<b>Step 3.</b>	Remove the jumper between pins 10 and 12.

## I. Activating Contact Closure Alarm Tones

To activate different sounds, short the corresponding pins with a dry contact closure as shown right (see **Installation**).

**Note:** *The evacuation sound and siren will be repeated continuously, as long as the closures are maintained.*

Sound	Short Pins...
Doorbell (Ding Dong)	...9 to 12
Siren (Yelp)	...10 to 12
Evacuation Sound (Slow Whoop)	...11 to 12

## J. Starting the CTG-1A Operation

When finished programming, press the **MODE** button until the **RUN** indicator lights. In the run mode, all buttons except the **MODE** button are disabled and the current time will be displayed with the colon flashing.

## K. Clearing the Alert Tone Memory

Momentarily press the **Mode** button until the **Events** LED lights. Simultaneously press the **Single** and **Cancel** buttons, release both and repeat. Pressing both buttons the second time will start the clearing process. When the clear process has finished, a long tone will be heard. If a second schedule is used, it will need to be cleared separately with dip switch 3 on.

## L. DIP Switch Settings

Switch	Position	Description
1	OFF	Program Bong alert tones *
1	ON	Program Buzzer alert tones
2	OFF	Send Tones mode *
2	ON	Timed Relay mode
3	OFF	Select Schedule 1 *
3	ON	Select Schedule 2
4	OFF	Use Standard Time *
4	ON	Use Daylight Saving Time
5	OFF	50 Hz power line frequency
5	ON	60 Hz power line frequency *

\* Factory Setting

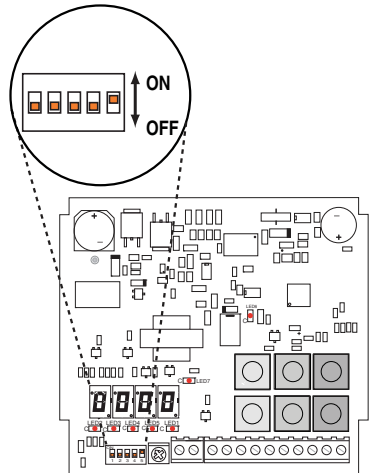

Internal View of the CTG-1A

## M. Timed Relay Mode

With DIP switch 2 in the OFF position, the **CTG-1A** will produce the selected tones at the programmed times. With DIP switch 2 in the ON position, the unit will operate the auxiliary relay according to the programmed times. An event programmed with the Single Tone will turn the relay on, and an event programmed with the Double or Triple alert tones will turn the relay off. If one of the contact closure controlled inputs (Emergency Siren, Evacuation or Doorbell) becomes active in the Timed Relay mode, the selected tone will be produced over the audio output but the current status of the relay will not change. The status of the relay will only change based on the programmed event schedule.

## N. Second Schedule

The **CTG-1A** can run one of two manually selected schedules as set by DIP switch 3. Each schedule can have up to 128 events in a 24 hour period as well as separate Day of Week programming.

**Note:** *The schedule selection should only be changed in the Time Mode.*

## O. Daylight Saving Time

DIP switch 4 provides an easy way to manually change to and from Daylight Saving Time. Moving the switch to the ON position will add 1 hour to the present time, and moving it to the OFF position will subtract an hour from the present time. If Daylight Savings Time is observed in your area, dip switch 4 should be set to on between the second Sunday in March and the first Sunday in November and set to off the rest of the year. If Daylight Savings Time is not observed in your area, leave dip switch 4 set to off all year. Note: Dip switch 4 should be set to the correct position before setting the clock time.

## P. Changing the Power Line Frequency Setting

Unplug the **CTG-1A** from power. Turn OFF Dip Switch 5 to change from 60 Hz to 50 Hz, or turn it ON to change from 50 Hz operation to 60 Hz. Power the **CTG-1A** back up. Set the **CTG-1A** to the current time.

## A. Send Tones Mode

When the clock time matches an event time in the current schedule (selected by dip switch 3) and that day is set to "ON" or "Aon", the **CTG-1A** will output the corresponding single, double or triple bong or buzzer alert tone. The **CTG-1A** will also open terminals 3 and 4 (normally closed) and close terminals 4 and 5 (normally open), allowing the capability of switching out the audio from the phone system and switching in the alert tone from the **CTG-1A**. Similarly, while a contact closure is made shorting pins 9, 10 or 11 to pin 12, the **CTG-1A** will output the corresponding sound (doorbell, evacuation signal or emergency siren). In the case of the siren or evacuation signal, terminals 3 and 4 will open, and terminals 4 and 5 will close and the sound will continue for the duration of the contact closure input. Terminals 3, 4 and 5 will return to their normal states at the end of each doorbell tone. Terminals 6, 7 and 8 will operate the same as terminals 3, 4 and 5 but are electrically isolated from terminals 3, 4 and 5 for switching a separate device.

To switch the **CTG-1A** from the current schedule to the second, use the MODE button to set the **CTG-1A** to the TIME mode, change the setting of dip switch 3 and use the MODE button to return the **CTG-1A** to the RUN mode. The **CTG-1A** is now running the other schedule and will output the single, double or triple bong or buzzer alert tones programmed in that schedule.

## B. Timed Relay Mode

The Timed Relay Mode of the **CTG-1A** changes its operation to a clock controlled relay output device, allowing the relay to be programmed to turn on or off at certain times of the day. Any day of the week can be set to "off" (or no relay operation) using the day of week programming. When the clock time matches an event time in the current schedule (selected by dip switch 3) and that day is set to "ON" or "Aon", the **CTG-1A** turns the relay on for a single event and turns the relay off for a double or triple event. When the relay is turned on by a single event, the **CTG-1A** will close terminals 4 and 5 (normally open) and open terminals 3 and 4 (normally closed). When the relay is turned off by a double or triple event, terminals 3, 4 and 5 will return to their normal states. Terminals 6, 7 and 8 will operate the same as terminals 3, 4 and 5 but are electrically isolated from terminals 3, 4 and 5 for switching a separate device.

To switch the **CTG-1A** from the current schedule to the second, use the MODE button to set the **CTG-1A** to the TIME mode, change the setting of dip switch 3 and use the MODE button to return the **CTG-1A** to the RUN mode. The **CTG-1A** is now running the other schedule and will turn the relay on and off based on the single, double or triple event times programmed in that schedule.

**IMPORTANT:** While operating, the **CTG-1A** continuously checks the event time information stored in memory. If a problem is detected, the **CTG-1A** displays "EEE" to indicate an error. Normal clock function continues in the background. To clear the error, press any button and the **CTG-1A** will return to normal operation.



# Sound Output Specifications

## A. Bong Alert Tone

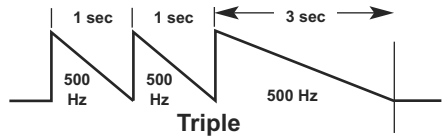
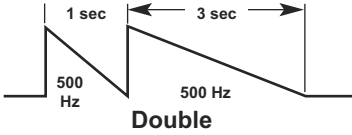
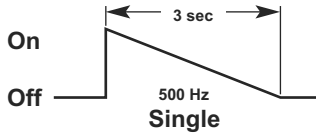

## B. Buzzer Alert Tone

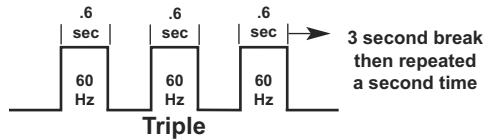
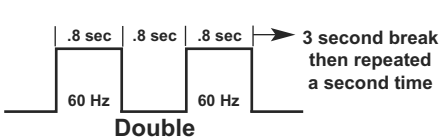
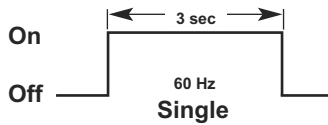

## C. Doorbell (Ding Dong)



## D. Siren (Yelp)

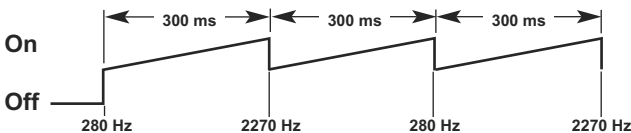

Continuously repeated while pin 10 is shorted to pin 12.

## E. Evacuation Signal (Temporal Slow Whoop)

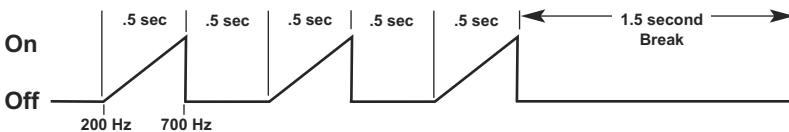

Continuously repeated while pin 11 is shorted to pin 12.

## Other Applications

Use Viking's **DVA-2WA** Digital Voice Announcer (**DOD 110**) in conjunction with a **CTG-1A** to provide time activated promotional voice messages over an existing paging system. The **CTG-1A** will be used only to provide time activated contact closures to the **DVA-2WA** for initiating multiple (up to 7.5 minutes total length) promotional messages. **Note:** *It is recommended that a UPS (uninterruptible power source) be used to maintain the proper message order in the **DVA-2WA** during a power outage.*

**Model CTG-1A Clock Controlled Tone Generator (DOD 461)**

**Model DVA-2WA Digital Voice Announcer (DOD 110)**

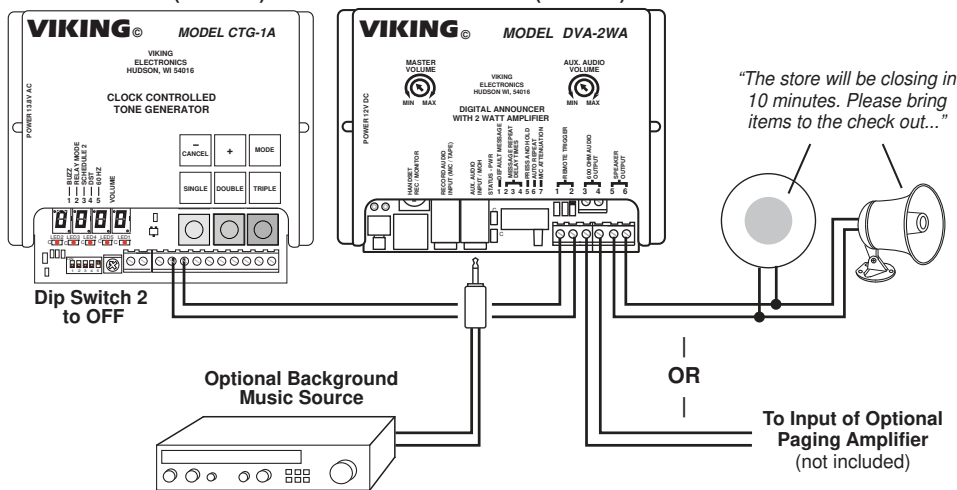

Use Viking's **C-250** Entry phone Controller with Call Forwarding (**DOD 172**) in conjunction with a **CTG-1A** to provide immediate call forwarding certain hours of the day. (Timed Relay Mode).

**Model CTG-1A Clock Controlled Tone Generator (DOD 461)**

**Model C-250 Entry Phone Controller with Call Forwarding (DOD 172)**

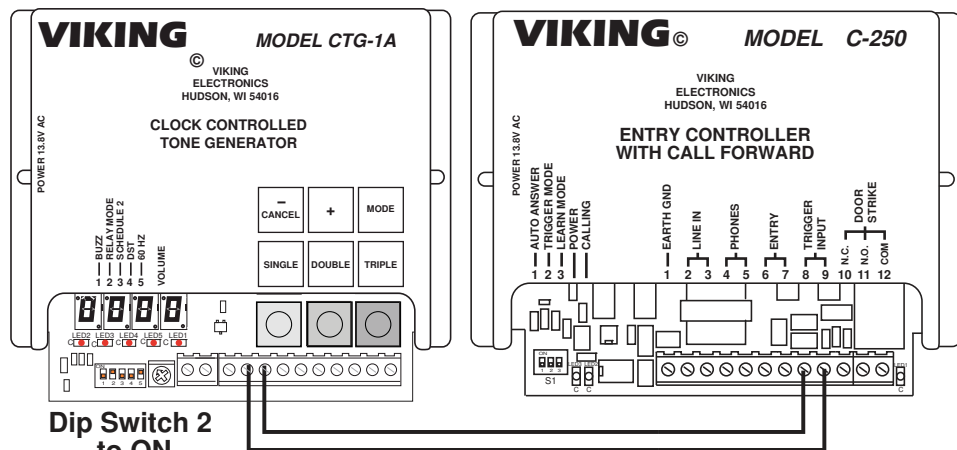

Use the Timed Relay Mode of the **CTG-1A** to limit the use of doorstrikes or maglocks to certain hours of the day.

## Model CTG-1A Clock Controlled Tone Generator (DOD 461)

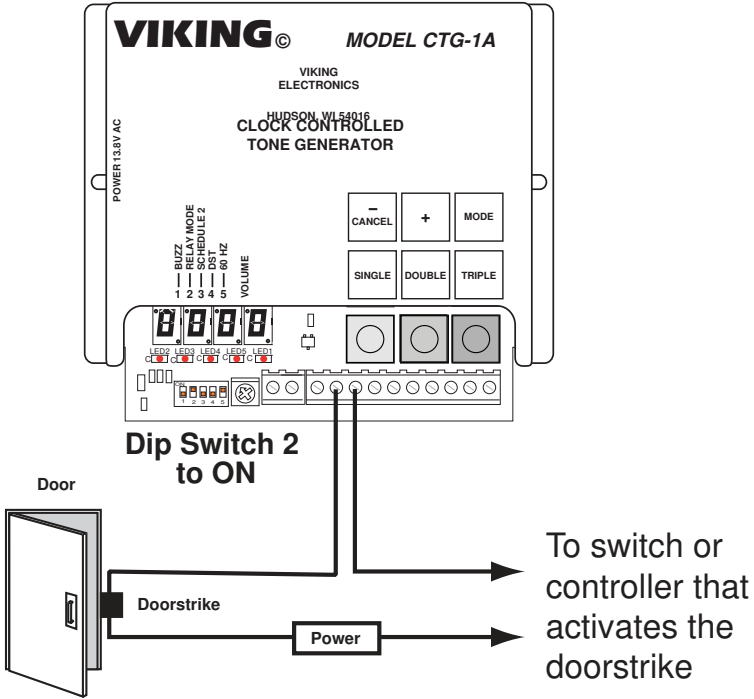

# Warranty

**IF YOU HAVE A PROBLEM WITH A VIKING PRODUCT, CONTACT: VIKING TECHNICAL SUPPORT AT 715-386-8666**

Our Technical Support Department is available for assistance Monday 8am through Friday 8am - 5pm central time. So that we can give you better service, before you call please:

1. Know the model number, the serial number and what software version you have (see serial label).
2. Have your Product manual in front of you.
3. It is best if you are on site.

## RETURNING PRODUCT FOR REPAIR

The following procedure is for equipment that needs repair:

1. Customer must contact Viking's Technical Support Department at 715-386-8666 to obtain a Return Authorization (RA) number. The customer MUST have a complete description of the problem, with all pertinent information regarding the defect, such as options set, conditions, symptoms, methods to duplicate problem, frequency of failure, etc.
2. Packing: Return equipment in original box or in proper packing so that damage will not occur while in transit. Static sensitive equipment such as a circuit board should be in an anti-static bag, sandwiched between foam and individually boxed. All equipment should be wrapped to avoid packing material lodging in or sticking to the equipment. Include ALL parts of the equipment. C.O.D. or freight collect shipments cannot be accepted. Ship cartons prepaid to: **Viking Electronics, 1531 Industrial Street, Hudson, WI 54016**
3. Return shipping address: Be sure to include your return shipping address inside the box. We cannot ship to a PO Box.
4. RA number on carton: In large printing, write the R.A. number on the outside of each carton being returned.

## RETURNING PRODUCT FOR EXCHANGE

The following procedure is for equipment that has failed out-of-box (within 10 days of purchase):

1. Customer must contact Viking's Technical Support at 715-386-8666 to determine possible causes for the problem. The customer MUST be able to step through recommended tests for diagnosis.
2. If the Technical Support Product Specialist determines that the equipment is defective based on the customer's input and troubleshooting, a Return Authorization (R.A.) number will be issued. This number is valid for fourteen (14) calendar days from the date of issue.
3. After obtaining the R.A. number, return the approved equipment to your distributor, referencing the R.A. number. Your distributor will then replace the Viking product using the same R.A. number.
4. **The distributor will NOT exchange this product without first obtaining the R.A. number from you. If you haven't followed the steps listed in 1, 2 and 3, be aware that you will have to pay a restocking charge.**

## TWO YEAR LIMITED WARRANTY

Viking warrants its products to be free from defects in the workmanship or materials, under normal use and service, for a period of two years from the date of purchase from any authorized Viking distributor. If at any time during the warranty period, the product is deemed defective or malfunctions, return the product to Viking Electronics, Inc., 1531 Industrial Street, Hudson, WI., 54016. Customer must contact Viking's Technical Support Department at 715-386-8666 to obtain a Return Authorization (R.A.) number.

This warranty does not cover any damage to the product due to lightning, over voltage, under voltage, accident, misuse, abuse, negligence or any damage caused by use of the product by the purchaser or others. This warranty does not cover non-EWP products that have been exposed to wet or corrosive environments. This warranty does not cover stainless steel surfaces that have not been properly maintained.

**NO OTHER WARRANTIES. VIKING MAKES NO WARRANTIES RELATING TO ITS PRODUCTS OTHER THAN AS DESCRIBED ABOVE AND DISCLAIMS ANY EXPRESS OR IMPLIED WARRANTIES OR MERCHANTABILITY OR FITNESS FOR ANY PARTICULAR PURPOSE.**

**EXCLUSION OF CONSEQUENTIAL DAMAGES. VIKING SHALL NOT, UNDER ANY CIRCUMSTANCES, BE LIABLE TO PURCHASER, OR ANY OTHER PARTY, FOR CONSEQUENTIAL, INCIDENTAL, SPECIAL OR EXEMPLARY DAMAGES ARISING OUT OF OR RELATED TO THE SALE OR USE OF THE PRODUCT SOLD HEREUNDER.**

**EXCLUSIVE REMEDY AND LIMITATION OF LIABILITY. WHETHER IN AN ACTION BASED ON CONTRACT, TORT (INCLUDING NEGLIGENCE OR STRICT LIABILITY) OR ANY OTHER LEGAL THEORY, ANY LIABILITY OF VIKING SHALL BE LIMITED TO REPAIR OR REPLACEMENT OF THE PRODUCT, OR AT VIKING'S OPTION, REFUND OF THE PURCHASE PRICE AS THE EXCLUSIVE REMEDY AND ANY LIABILITY OF VIKING SHALL BE SO LIMITED.**

**IT IS EXPRESSLY UNDERSTOOD AND AGREED THAT EACH AND EVERY PROVISION OF THIS AGREEMENT WHICH PROVIDES FOR DISCLAIMER OF WARRANTIES, EXCLUSION OF CONSEQUENTIAL DAMAGES, AND EXCLUSIVE REMEDY AND LIMITATION OF LIABILITY, ARE SEVERABLE FROM ANY OTHER PROVISION AND EACH PROVISION IS A SEPARABLE AND INDEPENDENT ELEMENT OF RISK ALLOCATION AND IS INTENDED TO BE ENFORCED AS SUCH.**

## FCC REQUIREMENTS

This equipment complies with Part 68 of the FCC rules and the requirements adopted by the ACTA. On the side of this equipment is a label that contains, among other information, a product identifier in the format US:AAEQ##TXXXX. If requested, this number must be provided to the telephone company.

The REN is used to determine the number of devices that may be connected to a telephone line. Excessive REN's on a telephone line may result in the devices not ringing in response to an incoming call. In most but not all areas, the sum of the REN's should not exceed five (5.0). To be certain of the number of devices that may be connected to a line, as determined by the total REN's, contact the local telephone company. For products approved after July 23, 2001, the REN for this product is part of the product identifier that has the format US:AAEQ##TXXXX. The digits represented by ## are the REN without a decimal point (e.g., 03 is a REN of 0.3). For earlier products, the REN is separately shown on the label.

The plug used to connect this equipment to the premises wiring and telephone network must comply with the applicable FCC Part 68 rules and requirements adopted by the ACTA. If your home has specially wired alarm equipment connected to the telephone line, ensure the installation of this CTG-1A does not disable your alarm equipment. If you have questions about what will disable alarm equipment, consult your telephone company or a qualified installer.

If the CTG-1A causes harm to the telephone network, the telephone company will notify you in advance that temporary discontinuance of service may be required. But if advance notice isn't practical, the telephone company will notify the customer as soon as possible. Also, you will be advised of your right to file a complaint with the FCC if you believe it is necessary.

The telephone company may make changes in its facilities, equipment, operations, or procedures that could affect the operation of the equipment. If this happens, the telephone company will provide advance notice in order for you to make the necessary modifications to maintain uninterrupted service.

If trouble is experienced with the CTG-1A, for repair or warranty information, please contact:

**Viking Electronics, Inc., 1531 Industrial Street, Hudson, WI 54016 (715) 386-8666**

If the equipment is causing harm to the telephone network, the telephone company may request that you disconnect the equipment until the problem is resolved.

Connection to Party Line Service is subject to State Tariffs. Contact the state public utility commission, public service commission or corporation commission for information.

**WHEN PROGRAMMING EMERGENCY NUMBERS AND (OR) MAKING TEST CALLS TO EMERGENCY NUMBERS:**

Remain on the line and briefly explain to the dispatcher the reason for the call. Perform such activities in the off-peak hours, such as early morning or late evenings.

It is recommended that the customer install an AC surge arrester in the AC outlet to which this device is connected. This is to avoid damaging the equipment caused by local lightning strikes and other electrical surges.

### PART 15 LIMITATIONS

This equipment has been tested and found to comply with the limits for a Class A digital device, pursuant to Part 15 of the FCC Rules. These limits are designed to provide reasonable protection against harmful interference when the equipment is operated in a commercial environment. This equipment generates, uses, and can radiate radio frequency energy and, if not installed and used in accordance with the instruction manual, may cause harmful interference to radio communications. Operation of this equipment in a residential area is likely to cause harmful interference in which case the user will be required to correct the interference at his own expense.

## Product Support: 715-386-8666

Due to the dynamic nature of the product design, the information contained in this document is subject to change without notice. Viking Electronics, and its affiliates and/or subsidiaries assume no responsibility for errors and omissions contained in this information. Revisions of this document or new editions of it may be issued to incorporate such changes.