

SIP Audible Ringer with Visual Ring Indication and Remote Strobe Light Control

The **SR-IP** is a SIP compliant PoE powered audio device for providing audible and visual ring indication for SIP VoIP phone systems. When registered with a SIP server, the **SR-IP** will ring in one of 4 programmable ring patterns and flash a bright red LED upon ring detection. During ring detection the units internal relay contacts will also activate providing a trigger for a Viking Model **SL-2** Strobe light or **LPL-1** visual ring indicator.

Equipped with a high efficiency Class D power amplifier and high quality loud speaker, the **SR-IP** is typically louder than a telephone speaker. The advanced features of the **SR-IP** include programmable Automatic Gain Control (AGC) technology which automatically increases ring volume to compensate for moderate background ambient noise. The AGC feature is ideal for



variable noise environments (offices, classrooms, restaurants, etc.), and ensures that ringing is heard but not unnecessarily loud.

⚠ Installation requires the assistance of a Network Administrator / IT Technician.

Features

- **Programming software included**
- **2 Amp relay contacts for Viking LPL-1 or SL-2 strobe light control**
- **Bright red visual ring indicator LED**
- **SIP compliant** (see page 2 for list of compatible IP-PBX phone systems)
- **PoE powered (class 2, <6.5 watts)**
- **Automatic Gain Control (AGC) to automatically increase ring volume to compensate for ambient noise**
- **Network downloadable firmware**
- Surface mounts to a single gang or 4" x 4" electrical box or directly to a wall or post
- Remotely programmable
- Extended temperature range (-40°F to 140°F)
- Remotely adjust ringer volume
- Four programmable ring cadences: normal (2 sec ON / 4 sec OFF), double, short-short-long, short-long-short
- Optional **LPL-1** Remote Visual Ring Indicator (**DOD 640**)
- Optional **SL-2 (DOD 242)** or **BLK-4-EWP (DOD 654)** strobe light kits available
- Diagnostics (for testing mic, speaker & relay)

Applications

- Ringer for variable noise environments (Offices, Classrooms, etc.)
- Visual Ring Indicator for quiet areas (Hospitals, Churches, Theaters, etc.)

www.VikingElectronics.com
Information: 715-386-8861

Specifications

Power: PoE class 2 (<6.5 watts)
Shipping Weight: 1.5 lbs (0.75kg)
Maximum Sound Pressure: 93 dB SPL @ 1m. **Note:** For applications requiring louder ring, see Viking model PA-IP.
Relay Output: SPDT contact, 2A @30VDC / 250VAC max
Dimensions: 5.5" x 4.5" x 1.7" (140mm x 115mm x 43mm)
Operating Temperature: -40°F to 140°F (-40° C to 60° C)
Humidity: 5% to 95% non-condensing
Audio Codecs: G711u, G711a, G722
Network Compliance: IEEE 802.3 af PoE, SIP 2.0 RFC3261, 100BASE-TX with auto cross over
Regulatory Compliance: FCC Part 15 and Canada ICES-3 Class A
Connections: (1) RJ45 10/100 Base-T, (3) gel-filled butt connectors

Definitions

Client: A computer or device that makes use of a server. As an example, the client might request a particular file from the server.

DHCP: Dynamic Host Configuration Protocol. In this procedure the network server or router takes note of a client's MAC address and assigns an IP address to allow the client to communicate with other devices on the network.

DNS Server: A DNS (Domain Name System) server translates domain names (ie: www.vikingelectronics.com) into an IP address.

Ethernet: Ethernet is the most commonly used LAN technology. An ethernet Local Area Network typically uses twisted pair wires to achieve transmission speeds up to 1Gbps.

Host: A computer or device connected to a network.

Host Name: A host name is a label assigned to a device connected to a computer network that is used to identify the device in various forms of network communication.

Hosts File: A file stored in a computer that lists host names and their corresponding IP addresses with the purpose of mapping addresses to hosts or vice versa.

Internet: A worldwide system of computer networks running on IP protocol which can be accessed by individual computers or networks.

IP: Internet Protocol is the set of communications conventions that govern the way computers communicate on networks and on the Internet.

IP Address: This is the address that uniquely identifies a host on a network.

LAN: Local Area Network. A LAN is a network connecting computers and other devices within an office or building.

Lease: The amount of time a DHCP server reserves an address it has assigned. If the address isn't used by the host for a period of time, the lease can expire and the address can be assigned to another host.

MAC Address: MAC stands for Media Access Control. A MAC address, also called a hardware address or physical address, is a unique address assigned to a device at the factory. It resides in the device's memory and is used by routers to send network traffic to the correct IP address. You can find the MAC address of your **SR-IP** printed on a white label on the top surface of the PoE LAN port.

Router: A device that forwards data from one network to another. In order to send information to the right location, routers look at IP Address, MAC Address and Subnet Mask.

Server: A computer or device that fulfills requests from a client. This could involve the server sending a particular file requested by the client.

Session Initiation Protocol (SIP): Is a signaling communications protocol, widely used for controlling multimedia communication sessions such as voice and video calls over Internet Protocol (IP) networks. The protocol defines the messages that are sent between endpoints, which govern establishment, termination and other essential elements of a call.

Static IP Address: A static IP Address has been assigned manually and is permanent until it is manually removed. It is not subject to the Lease limitations of a Dynamic IP Address assigned by the DHCP Server. The default Static IP Address is 192.168.154.1

WAN: Wide Area Network. A WAN is a network comprising a large geographical area like a state or country. The largest WAN is the Internet.

Features Overview

Front View of SR-IP

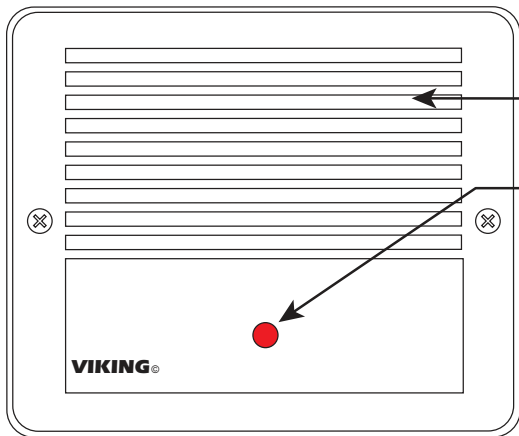

Internal View of SR-IP

- Reset Switch
- Microphone for Automatic Gain Control (AGC)
- LED Ring Indicator
- Green Unit Status LED
- Yellow Network Status LED: Lights steady to indicate power and data link. Blinks to indicate network activity.

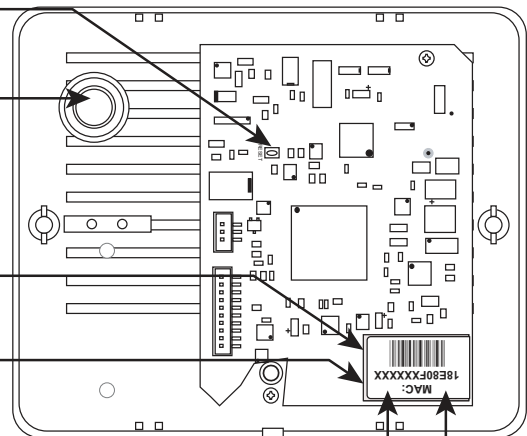

PoE LAN Port 10/100, PoE Class 2 (<6.5 Watts): Connect to your LAN via RJ45 plug and CAT5 or greater twisted pair wire.

MAC Address Label: The MAC address is a unique 12 digit number used by routers to send network traffic to the correct IP address.

Installation

A. Wiring

Connect to Optional Strobe Light, etc.

Light Steady (Beacon) When Idle

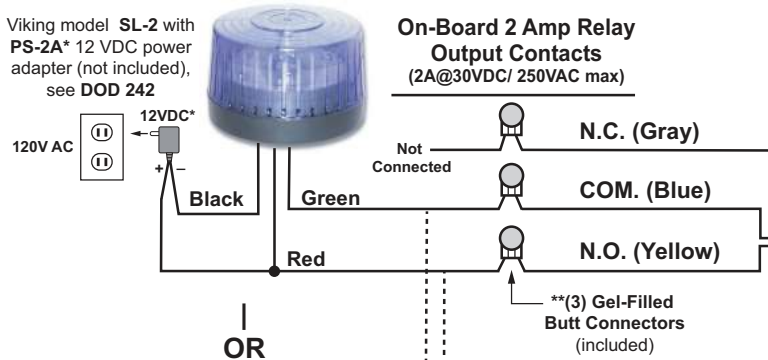

Off (NO Beacon) When Idle

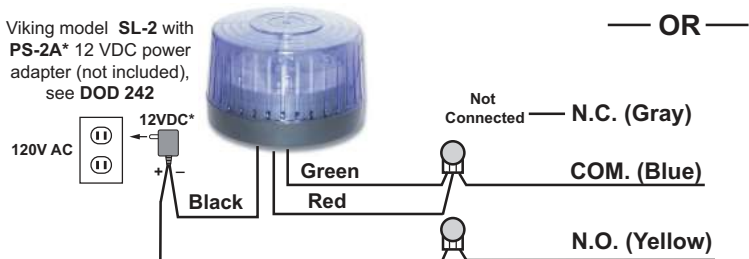

Rear View of SR-IP

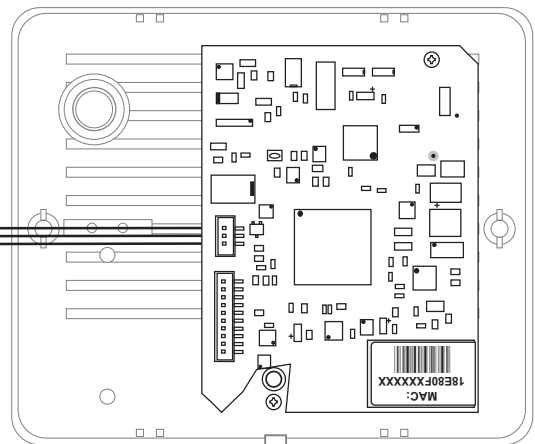

Connect to Optional Remote Visual Ring Indicator

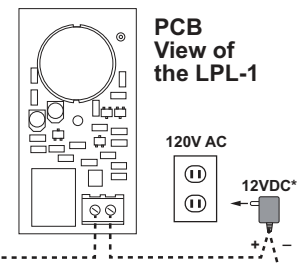

* **Note:** To purchase the PS-2A power adapter (part # L120950), go to www.vikingelectronics.com and click on Spare Parts.

** **Note:** The gel-filled (water-tight) butt connectors are designed for insulation displacement on 19-26 gauge wire with a maximum insulation of 0.082 inches. Cut off stripped wire ends before terminating.

Viking model LPL-1 (DOD 640) with Viking model PS-2A* 12 VDC power adapter

B. Mounting

The **SR-IP** is designed to be surface mounted to a single gang box (not included), a standard 4" x 4" electrical junction box (not included), or directly to a wall or flat sided post.

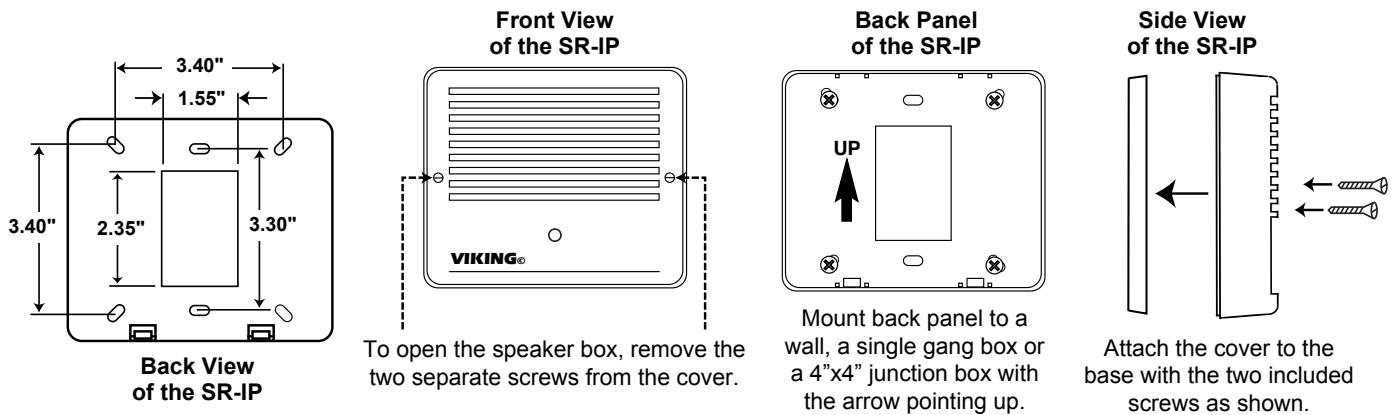

Typical Installation on SIP Based VoIP Phone System

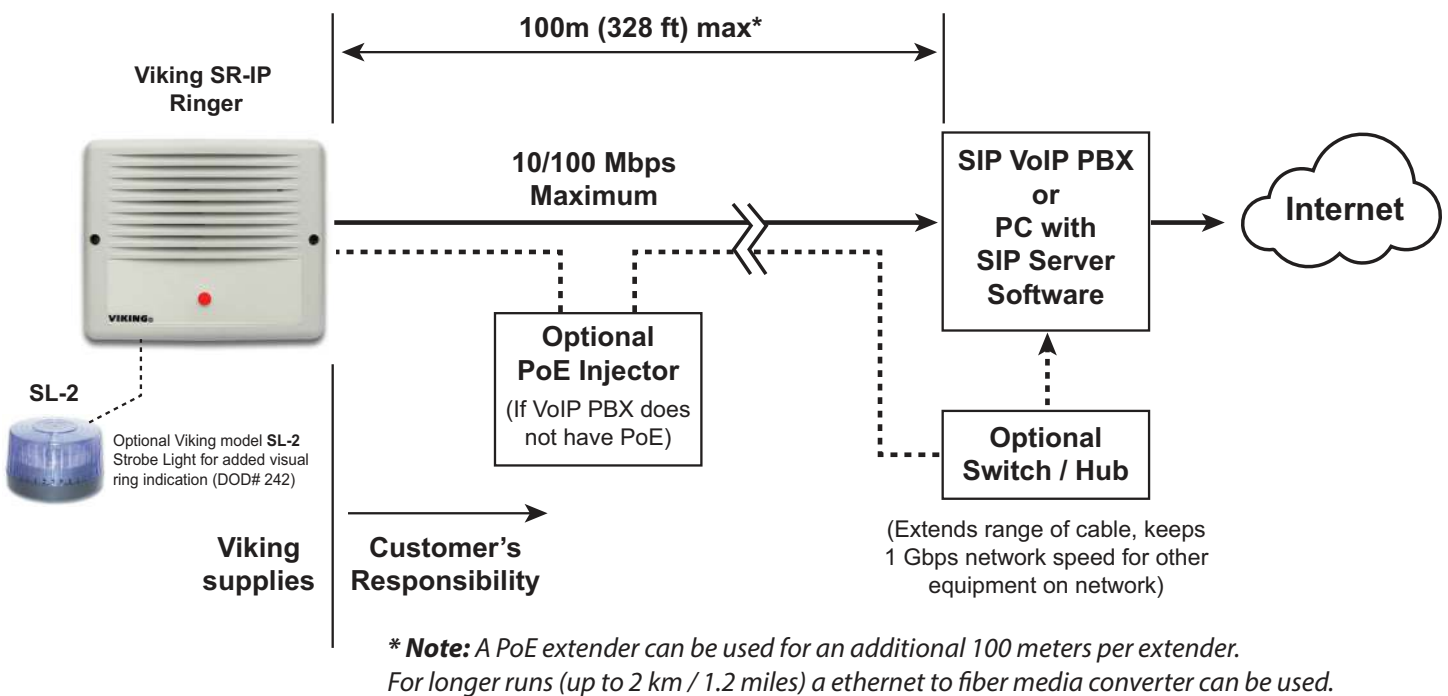

PC Requirements

- **IBM** compatible personal computer with: Windows 7, 8 or 10
- Adobe Acrobat Reader 8 or higher
- **SR-IP** hardware
- Available LAN with PoE (class 2, <6.5 watts)
- Ethernet cable (CAT5 min.)
- 1 MB minimum free hard drive space for installation
- 16MB of free physical RAM

PC Programming

Download and install the programming software

1. Go to www.vikingelectronics.com and enter **SR-IP** in the search box
2. Click **SR-IP** in the search results
3. Scroll down the page to Downloads, click **IP Programming Software**
4. Install the programming software by saving or opening the file and then clicking on **setup Viking IP Programming.exe**
5. Follow the prompts on your screen to complete software installation
6. To start the Viking IP Programming application, click on the Viking IP Programming icon on your desktop. The Main screen will appear, allowing the user to program any **SR-IP** connected to that LAN.

Note: PC must be connected to the same LAN as the **SR-IP**.

A. Connect / Disconnect

Open the “Viking IP Programming” software on the PC and the start screen shown below will appear. Any Viking IP products that are connected to the network will appear on the list. Simply select the **SR-IP** on the list and click on the “Connect” button at the bottom or double click the selected unit. If the security code of the selected unit is still set to default (845464), the PC software will not require entering a security code to connect to the unit. **SR-IP**'s have a default name of “VIKING_MK64_Vik02”, so if many devices are connected to the same network that all have the default name, MAC addresses must be used to identify each unit.

When finished programming, click on the “Disconnect” button at the bottom. Closing the program will also automatically disconnect the unit.

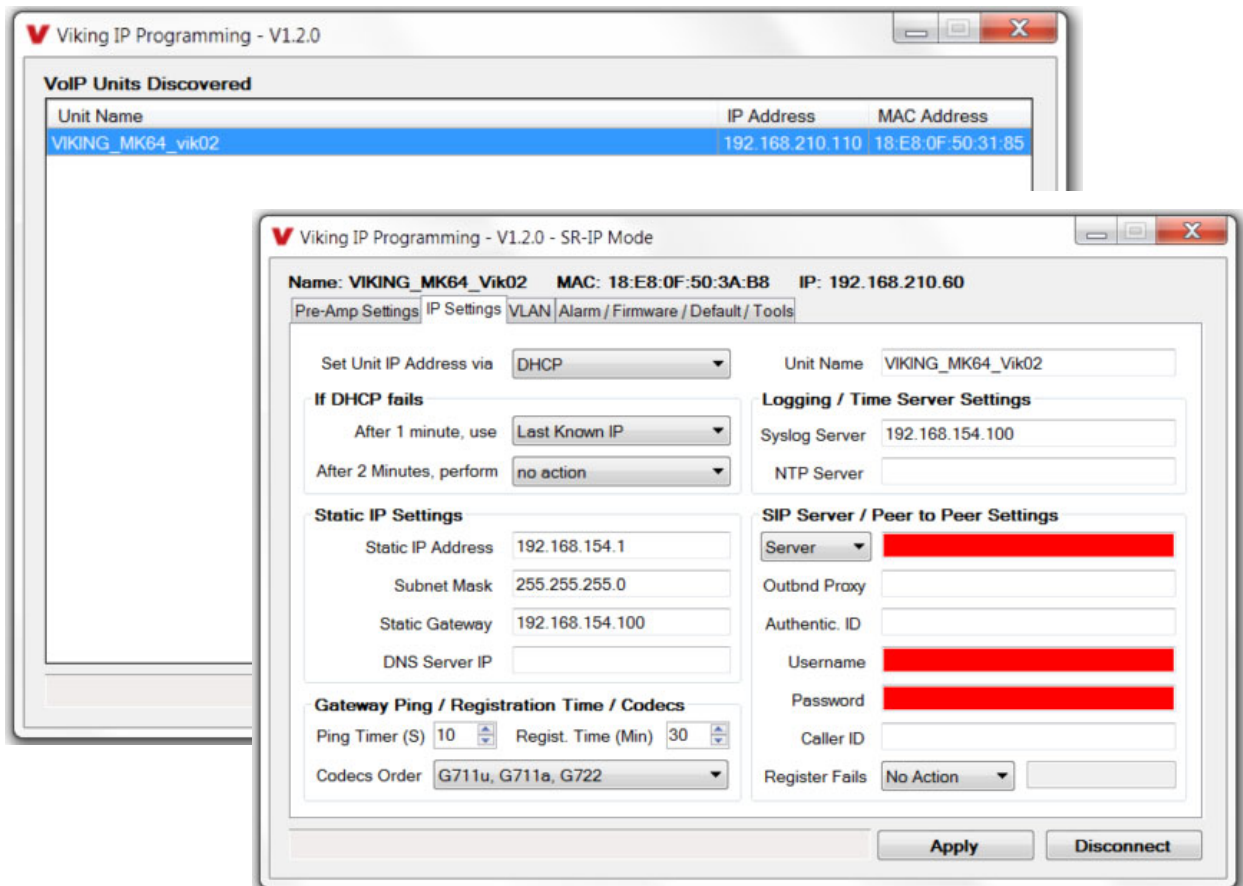

B. Manually Muting SIP / Network Failure Alarm Beeps (3 beeps repeated every 30 seconds)

With the unit connected and powered (Green LED on and Yellow LED off or blinking) it will output 3 beeps every 30 seconds and turn the LED on and off once per second indicating a SIP registration failure, failure to receive an echo reply from pinged gateway or Ethernet connection failure. You can manually disable the beeps by pressing and holding the Reset switch for 5 seconds (2 beeps will then be heard) or by clicking the “Mute Alarm Until Next Failure” tab in the Viking VoIP programming software. The LED will continue to flash allowing you to trouble shoot the failure.

C. Configuring the SR-IP Network Settings

Step 1.	Open the “Viking IP Programming” software on a windows PC that is connected to the same LAN as the SR-IP unit to be programmed.
Step 2.	The window in the upper left corner of the menu will show you each SR-IP that is connected to that LAN. Select the unit with the same MAC address shown on the label located on the top of the Ethernet connector on the SR-IP .
Step 3.	Click the “Connect” button. If a pop up window appears, enter the unit’s security code (factory set to 845464) then click “OK”.
Step 4.	The program will then read and display the SR-IP ’s IP and programming settings.
Step 5.	Click on the “IP Settings” tab.
Step 6.	Select the appropriate value Static IP Settings or DHCP for “Set Unit IP Address via”. Note: changing the IP address will cause you to have to reconnect to the unit. Enter the values for the fields in “if DHCP fails” or “Static IP Settings” as needed.
Step 7.	Set the “Unit Name”, “Logging / Time Server Settings” as needed.
Step 8.	Select Peer-Peer in the “SIP Server / Peer to Peer Settings” to use the unit in Peer to Peer mode. Select Server to register with a SIP registrar server and fill in the “Outbnd Proxy” (SIP Outbound Proxy Server Address, “ip:port”), “Authentic. ID” (SIP Authentication ID), “Username” (SIP Username, <string>), “Password” (SIP Password), and “Caller ID” (SIP Caller ID) with values from your VoIP provider.

D. Configuring SR-IP VLAN Settings

Step 1.	Click on the "VLAN" tab
Step 2.	Disable or enable VLAN tagging by setting the value of "VLAN Tagging".
Step 3.	Set the VLAN tag ID by selecting an integer (1 to 4094) in "ID for all packets".
Step 4.	Set the Priority Code Point (PCP) value for all not SIP and RTP packets in the "PCP for all packets" input (0 is default, priorities are from low to high: 0, 1, 2, 3, 4, 5, 6, 7). Set the "PCP for SIP packets" (3 is default). Set the "PCP for RTP packets" (5 is default).

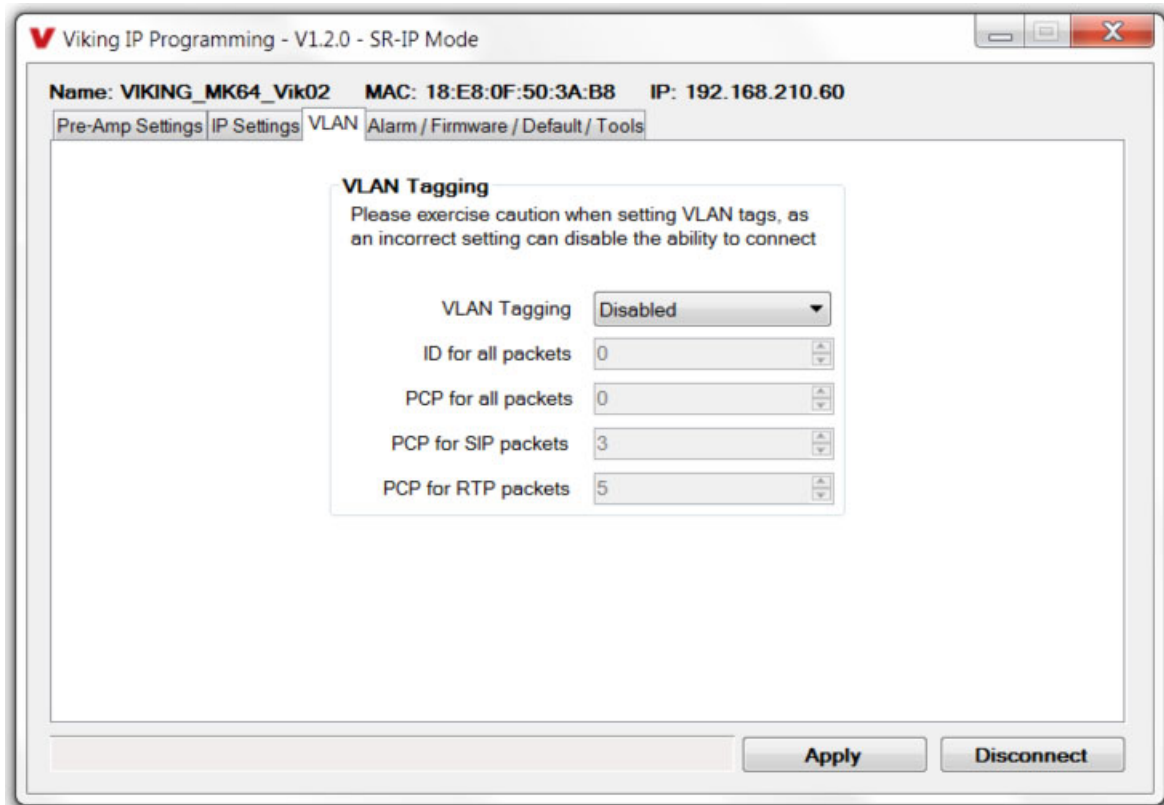

E. Manually Resetting the Security Code to Enter Programming

Step 1.	Power down the SR-IP by disconnecting the LAN Cable (RJ45 plug).
Step 2.	Press and hold the Reset button, then reconnect the LAN Cable (RJ45 plug).
Step 3.	Continue to hold Reset button until you hear 2 beeps, (approximately 6 seconds). Then release the button. The LED will remain off for the first 3 seconds, flash slowly for 3 seconds then fast flash (after 2 beeps), indicating when to release button.
Step 4.	The security code is now reset to 845464 (factory default).
Step 5.	You can now enter programming by following the steps in section A .

F. Manually Resetting All Network Parameters to Factory Default

Step 1.	Power down the SR-IP by disconnecting the LAN Cable (RJ45 plug).
Step 2.	Press and hold the Reset button, then reconnect the LAN Cable (RJ45 plug).
Step 3.	Continue to hold the Reset button until you hear 2 beeps, (approximately 6 seconds). Continue to hold reset button until you hear 4 more beeps, approximately 6 seconds later, then release the button. The LED will remain off for the first 3 seconds, flash slowly for 3 seconds (2 beeps), fast flash for 6 seconds (4 beeps), then light steady indicating when to release button.
Step 4.	You can now enter programming by following the steps in section A .

Programming Features Index

DESCRIPTION	Section	Page
Connect/Disconnect	A	6
VLAN Settings	D	8
Unit Name	1	9
SIP Server	2	9
Peer to Peer Settings	3	9
Outbound Proxy	4	10
Authentication ID	5	10
Register Fails	6	10
Security code (factory set to 845464)	7	10
Internal / External Relay (factory set to Internal)	8	10
Relay Mode (Ring, Ring Flash, factory set to Ring)	9	11
LED Mode (ON, OFF, factory set to ON)	10	11
Speaker Mode (ON, OFF , factory set to ON)	11	11
Ring Mode (Ring, Ring with AGC, factory set to Ring)	12	11
Ring Cadence (Normal, Double, Short-Short-Long, Short-Long-Short, factory set to Normal, 2 seconds on 4 seconds off)	13	11
Ring Volume (0-9, factory set to 5)	14	11
Mute Current / Next Alarm	15	12
Permanent Alarm Mute	16	12
IP Firmware	17	12
Unit Firmware	18	12
Import/Export	19	13
Clear Unit Settings	20	13
Clear IP Settings	21	13
Diagnostics (used to check mic, speaker and relay operations)	22	13

Programming Features

1. Unit Name

Up to a 31 character unit name can be assigned to the **SR-IP** being programmed.

2. SIP Server

Enter the IP address or URL of your SIP server or service provider in this field. The SIP server IP address is limited to 74 characters. **Note:** *If an alternate SIP server IP address is programmed, the IP address for the SIP server and alternate SIP server will be limited to 31 characters.* **Note:** *If outbound proxy is not required, enter the SIP server IP address into the Outbnd Proxy field.*

3. Peer to Peer Settings

When set to Peer to Peer mode a SIP server is not used. The unit should be programmed with a Static IP Address and Username, a password is not used. Caller ID can be programmed if needed. Simply call the unit by entering the programmed “username@192.168...(Static IP address for the unit)”. The static IP address is normally programmed into a page button on the VoIP telephones.

4. Outbound Proxy

If your SIP provider requires an outbound proxy IP address enter it in the Outbnd Proxy field. If outbound proxy is not required enter the SIP sever IP address into the Outbnd Proxy field. **NOTE:** *If not required, this field must match your SIP server IP address.*

5. Authentication ID

If your SIP provider requires Authentication ID, enter it in the Authentic. ID field. If Authentication ID is not required, leave this field blank.

6. Register Fails (Re-Resolve or Alternate Server)

When registered to a SIP server in the event that registration is lost you can program the unit to re-resolve using the current SIP server IP address or route pages through an alternate SIP server. With Alternate Server selected enter the IP address of the alternate SIP server in the field next to the Register Fails drop down box. **Note:** *With an alternate SIP server IP address programmed, the IP address for the SIP server and alternate SIP server will be limited to 31 characters.*

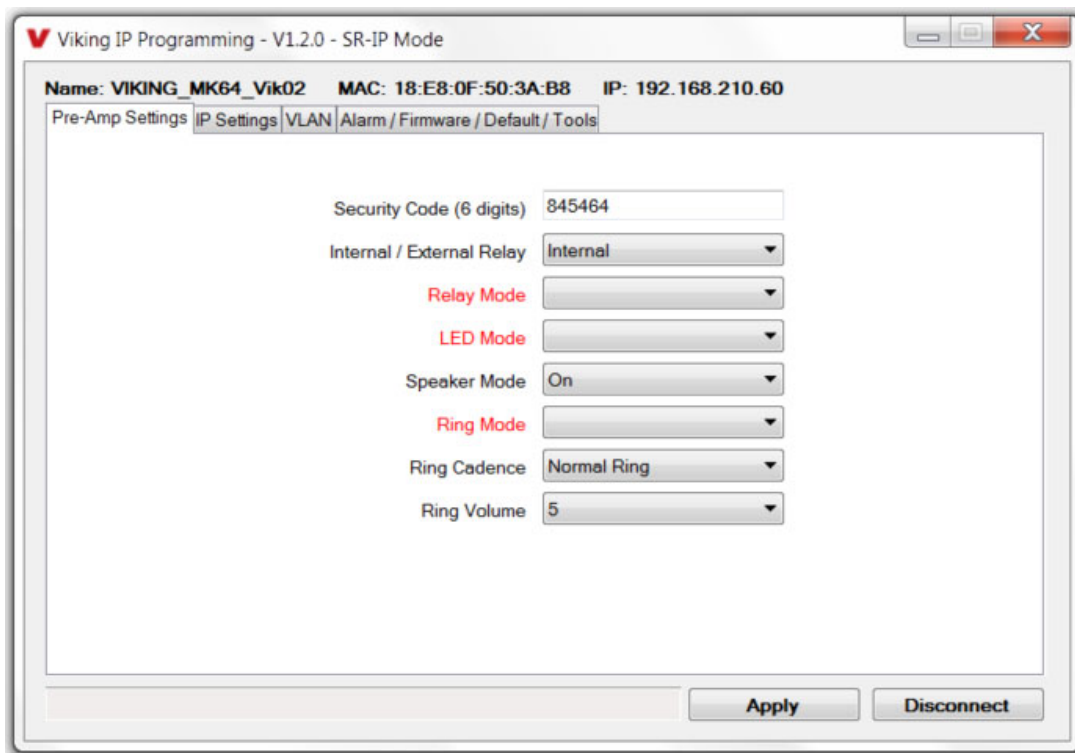

7. Security Code

The security code allows the user/installer to program the **SR-IP**. The factory set security code is 845464. It is recommended that the factory set security code be changed.

Note: *The security code must be 6 digits and cannot include a * or a #.*

8. Relay Internal / External

With the relay set to “Internal” the **SR-IP** will activate its on board relay for door strike / gate control. The Relay should be set to “External” for higher security installations when using a Viking remote model **RC-4A** relay controller to activate the door strike / gate controller (see DOD 582). Factory Setting: Internal

9. Relay Mode

The 2 amp relay contacts can be programmed to one of two different modes in programming:

Ring Mode: When programmed for Ring Mode the relay will continuously activate while the ringing extension is called. This mode is useful for activating a Viking model **SL-2** strobe light, etc.

Ring Flash Mode: When programmed for Ring Flash Mode the relay will momentarily turn on and off in a 400msec on/off cadence while the ringing extension is called. This mode is useful for activating a Viking model **LPL-1** remote visual ring indicator, etc.

Factory Setting: Ring Mode

10. LED Mode

The LED Mode can be set to one of the following two modes:

OFF: In the "OFF" mode the LED is disabled at all times. This mode is useful when using the **SR-IP** for audible ring indication only.

ON: In the "ON" mode the LED will flash while the extension is ringing.

Factory Setting: ON

11. Speaker Mode

The Speaker Mode can be set to one of the following two modes:

OFF: In the "OFF" mode the speaker is disabled at all times. This mode is useful when using the **SR-IP** for visual ring indication only.

ON: In the "ON" mode the speaker is enabled.

Factory Setting: ON

12. Ring Mode

The Speaker Mode can be set to one of the following two modes:

Ring: In the "Ring" mode the unit will not automatically answer an incoming call but will output a loud ring signal out of the speaker in a 2 seconds on, 4 seconds off ring pattern. There are four available ring cadences.

Ring with AGC: In the "Ring with AGC" mode the unit will not automatically answer an incoming call but will output a loud ring signal out of the speaker in a 2 seconds on, 4 seconds off ring pattern. The unit will automatically increase or decrease the ring volume based on background ambient noise. The call can then be answered by momentarily pressing the call button.

Factory Setting: Ring

13. Ring Cadence

The Ring cadence can be programmed to one of 4 different cadences:

Normal Ring (single ring, 2 sec on 4 sec off) factory setting

Double Ring (double ring, 1 sec on .5 sec off 1 sec on 3.5 sec off)

Short-Short-Long (triple ring, .5 sec on .5 sec off .5 sec on .5 sec off 1 sec on 3 sec off)

Short-Long-Short (triple ring, .5 sec on .5 sec off 1 sec on .5 sec off .5 sec on 3 sec off)

Factory Setting: Normal

14. Ring Volume

When set to Ring or Ring with AGC, The **SR-IP** will output a loud ring when it is called. The level can be adjusted from 0-9. Factory Setting: 5

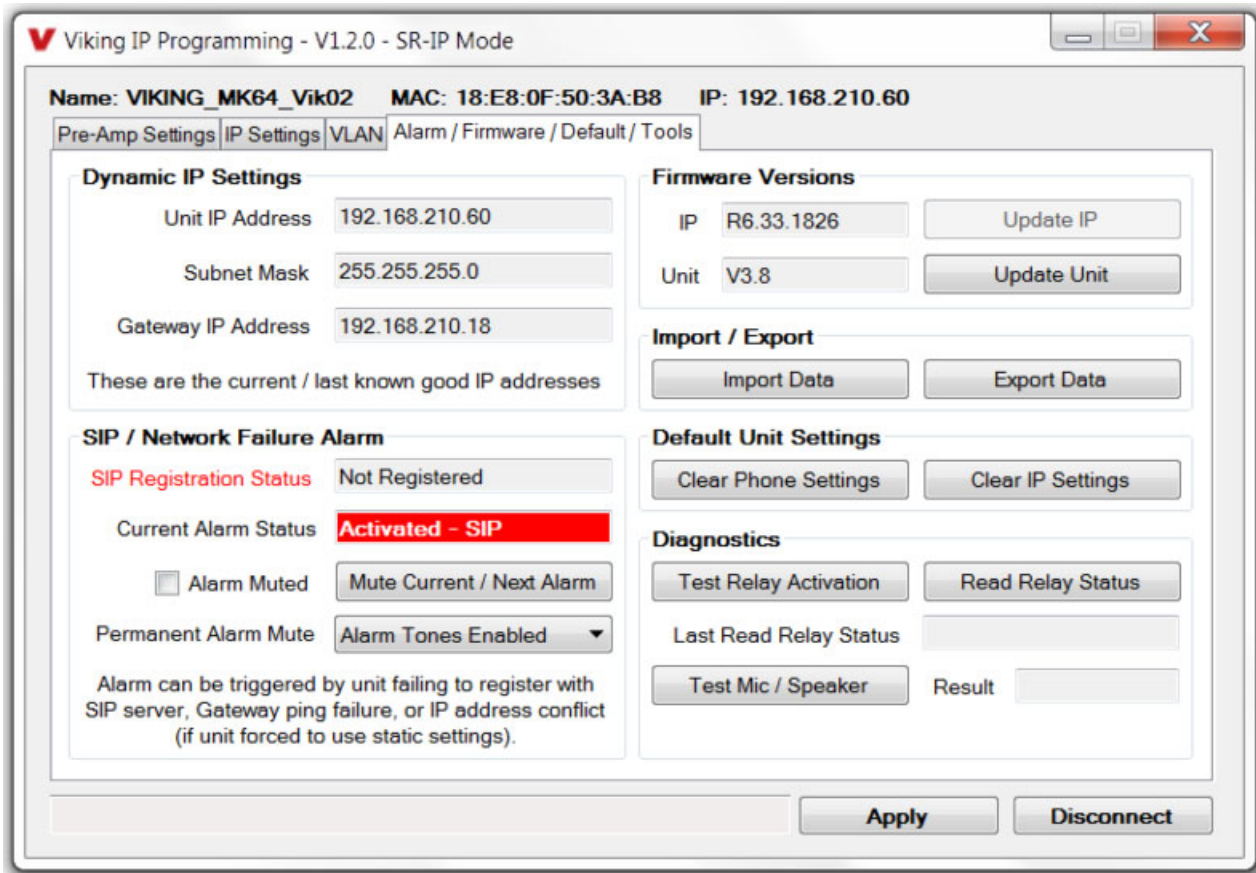

15. Mute Current / Next Alarm

A network failure alarm will be indicated by providing 3 beeps every 30 seconds. A network failure indicates the unit is not registered to the SIP server or there is a communication failure with the gateway. The three beeps can be muted by clicking on “Mute Current / Next Alarm”. The Status LED will continue to flash to assist troubleshooting. The alarm beeps can also be permanently disabled. See Permanent Alarm Mute.

16. Permanent Alarm Mute

Selecting “Alarm Tones Disabled” will mute all alarm tones indefinitely. To re-enable alarm tones select “Alarm Tones Enabled”.

17. IP Firmware

If new Unit firmware is available, after opening the programming software a pop window will come up asking you if you would like to update firmware. An alternative method of updating can be done by clicking the IP firmware “Update IP” button. You can then browse to the folder that contains the PIP file for updating the unit’s IP firmware. This method is typically only used when Viking Technical Support has sent you updated IP firmware

18. Unit Firmware

If new Unit firmware is available, after opening the programming software a pop up window will ask if you would like to update firmware. Another way to update is accomplished by clicking the Unit firmware “Update Unit” button. You can then browse to the folder that contains the HEX file for updating the unit’s firmware. This method is typically only used when Viking Technical Support has sent you updated firmware.

19. Import / Export

The Import / Export feature is useful for backing up all the Unit's programming or for importing programming when installing multiple units with a majority of the same programming.

20. Clear Unit Settings

Clicking on the "Clear Unit Settings" button in programming will reset all of the Programming Features back to their factory default settings. **Note:** *This command will not change or reset your IP settings.*

21. Clear IP Settings

Clicking on the "Clear IP Settings" will reset all of the IP settings back to their factory default settings. This also clears paging Group settings and Addresses. **Note:** *This will not effect any speaker or paging settings.*

22. Diagnostics

The Diagnostics section in the Viking IP Programming can be used to test the functionality of the mic, speaker and the on-board relay. **Note:** *This will not work when relay mode is set to external or Alarm.*

Connection/Operation

The **SR-IP** connects to an on-premise SIP VoIP phone system or hosted communication server in the same way as a SIP telephone. To register the **SR-IP** with the server requires the following information: **1.** IP address (e.g. 192.168.1.1) of the SIP Server **2.** User Name (e.g. SIP extension number) **3.** Password. When the Ringing extension is called the **SR-IP** will not answer. Instead it will warble in the selected ring pattern until the ringing stops. Typically the ringing extension is programmed as part of a hunt group so that it receives ring signal simultaneously with one or more phones to function as a loud ringer in noisy or large areas.

Troubleshooting

If the unit cannot register with the programmed SIP server, the LED will blink on and off every two seconds, and three error beeps will be heard every 30 seconds until communication is restored. This alerts a potential user of a problem with the device.

You may silence the error beeps, per instance, by pressing and holding the Reset Switch for 5 seconds or by clicking the "Mute Alarm Until Next Failure" button in the Viking IP Programming Software (see section **B** on page 7). The error beeps automatically re-enable once the unit is registered, to alert of any new problems that arise.

Warranty

IF YOU HAVE A PROBLEM WITH A VIKING PRODUCT, CONTACT: VIKING TECHNICAL SUPPORT AT 715-386-8666

Our Technical Support Department is available for assistance Monday through Friday 8:00am - 5:00pm central time. So that we can give you better service, before you call please:

1. Know the model number, the serial number and what software version you have (see serial label).
2. Have your Product Manual in front of you.
3. It is best if you are on site.

RETURNING PRODUCT FOR REPAIR

The following procedure is for equipment that needs repair:

1. Customer must contact Viking's Technical Support Department at 715-386-8666 to obtain a Return Authorization (RA) number. The customer MUST have a complete description of the problem, with all pertinent information regarding the defect, such as options set, conditions, symptoms, methods to duplicate problem, frequency of failure, etc.
2. Packing: Return equipment in original box or in proper packing so that damage will not occur while in transit. Static sensitive equipment such as a circuit board should be in an anti-static bag, sandwiched between foam and individually boxed. All equipment should be wrapped to avoid packing material lodging in or sticking to the equipment. Include ALL parts of the equipment. C.O.D. or freight collect shipments cannot be accepted. Ship cartons prepaid to: **Viking Electronics, 1531 Industrial Street, Hudson, WI 54016**
3. Return shipping address: Be sure to include your return shipping address inside the box. We cannot ship to a PO Box.
4. RA number on carton: In large printing, write the R.A. number on the outside of each carton being returned.

RETURNING PRODUCT FOR EXCHANGE

The following procedure is for equipment that has failed out-of-box (within 10 days of purchase):

1. Customer must contact Viking's Technical Support at 715-386-8666 to determine possible causes for the problem. The customer MUST be able to step through recommended tests for diagnosis.
2. If the Technical Support Product Specialist determines that the equipment is defective based on the customer's input and troubleshooting, a Return Authorization (R.A.) number will be issued. This number is valid for fourteen (14) calendar days from the date of issue.
3. After obtaining the R.A. number, return the approved equipment to your distributor, referencing the R.A. number. Your distributor will then replace the Viking product using the same R.A. number.
4. **The distributor will NOT exchange this product without first obtaining the R.A. number from you. If you haven't followed the steps listed in 1, 2 and 3, be aware that you will have to pay a restocking charge.**

TWO YEAR LIMITED WARRANTY

Viking warrants its products to be free from defects in the workmanship or materials, under normal use and service, for a period of two years from the date of purchase from any authorized Viking distributor. If at any time during the warranty period, the product is deemed defective or malfunctions, return the product to Viking Electronics, Inc., 1531 Industrial Street, Hudson, WI., 54016. Customer must contact Viking's Technical Support Department at 715-386-8666 to obtain a Return Authorization (R.A.) number.

This warranty does not cover any damage to the product due to lightning, over voltage, under voltage, accident, misuse, abuse, negligence or any damage caused by use of the product by the purchaser or others. This warranty does not cover non-EWP products that have been exposed to wet or corrosive environments. This warranty does not cover stainless steel surfaces that have not been properly maintained.

NO OTHER WARRANTIES. VIKING MAKES NO WARRANTIES RELATING TO ITS PRODUCTS OTHER THAN AS DESCRIBED ABOVE AND DISCLAIMS ANY EXPRESS OR IMPLIED WARRANTIES OR MERCHANTABILITY OR FITNESS FOR ANY PARTICULAR PURPOSE.

EXCLUSION OF CONSEQUENTIAL DAMAGES. VIKING SHALL NOT, UNDER ANY CIRCUMSTANCES, BE LIABLE TO PURCHASER, OR ANY OTHER PARTY, FOR CONSEQUENTIAL, INCIDENTAL, SPECIAL OR EXEMPLARY DAMAGES ARISING OUT OF OR RELATED TO THE SALE OR USE OF THE PRODUCT SOLD HEREUNDER.

EXCLUSIVE REMEDY AND LIMITATION OF LIABILITY. WHETHER IN AN ACTION BASED ON CONTRACT, TORT (INCLUDING NEGLIGENCE OR STRICT LIABILITY) OR ANY OTHER LEGAL THEORY, ANY LIABILITY OF VIKING SHALL BE LIMITED TO REPAIR OR REPLACEMENT OF THE PRODUCT, OR AT VIKING'S OPTION, REFUND OF THE PURCHASE PRICE AS THE EXCLUSIVE REMEDY AND ANY LIABILITY OF VIKING SHALL BE SO LIMITED.

IT IS EXPRESSLY UNDERSTOOD AND AGREED THAT EACH AND EVERY PROVISION OF THIS AGREEMENT WHICH PROVIDES FOR DISCLAIMER OF WARRANTIES, EXCLUSION OF CONSEQUENTIAL DAMAGES, AND EXCLUSIVE REMEDY AND LIMITATION OF LIABILITY, ARE SEVERABLE FROM ANY OTHER PROVISION AND EACH PROVISION IS A SEPARABLE AND INDEPENDENT ELEMENT OF RISK ALLOCATION AND IS INTENDED TO BE ENFORCED AS SUCH.

If trouble is experienced with the **SR-IP** loud ringer, for repair or warranty information, please contact:

Viking Electronics, Inc., 1531 Industrial Street, Hudson, WI 54016 (715) 386-8666

WHEN PROGRAMMING EMERGENCY NUMBERS AND (OR) MAKING TEST CALLS TO EMERGENCY NUMBERS:

Remain on the line and briefly explain to the dispatcher the reason for the call. Perform such tests in off-peak hours, such as early morning or late evenings.

PART 15 LIMITATIONS

This equipment has been tested and found to comply with the limits for a Class A digital device, pursuant to Part 15 of the FCC Rules. These limits are designed to provide reasonable protection against harmful interference when the equipment is operated in a commercial environment. This equipment generates, uses, and can radiate radio frequency energy and, if not installed and used in accordance with the instruction manual, may cause harmful interference to radio communications. Operation of this equipment in a residential area is likely to cause harmful interference in which case the user will be required to correct the interference at his own expense.

CANADA

This class A digital apparatus complies with Canadian ICES-003. Cet appareil numérique de la classe A est conforme a la norme NMB-003 du Canada.

Product Support: 715-386-8666

Due to the dynamic nature of the product design, the information contained in this document is subject to change without notice. Viking Electronics, and its affiliates and/or subsidiaries assume no responsibility for errors and omissions contained in this information. Revisions of this document or new editions of it may be issued to incorporate such changes.